

PREVOST

Pneumatic diagram

PNEUMATIC DIAGRAMS H3-45 COACHES WITH INDEPENDENT SUSP.

NO:	D140380P0	REVISION :	G
-----	------------------	------------	----------

EFF. OC#	2010001	PRIOR TO OC#	2012005
EFF. VEH#	#B-1721	PRIOR TO VEH#	#C-2054

DR.	R. Bouillon	date	2012-02-05
CHK	Marc-Jose Handfield	appr	Marc-José Handfield

REV.	DATE	DESCRIPTION	PAGE	BY	CHK.	APPR.
A	2010-09-27	Coach H3-45 with Independent Front Suspension IFS, NEW EPA VOLVO ENGINE 2010 Preliminary Vehicle #A-1573, #A-1627, #A-1636, #B-1695 Production Vehicle #B-1721...		Rob.	M.J.H.	M.J.H.
B	2010-09-27	#D140380 P10.0 REVISION: B Production Vehicle #B-1721...	P10.0 & 10.1	Rob.	M.J.H.	M.J.H.
C	2011-05-18	#D140380 P8.0 REVISION: B (AHI REPLACED) #D140380 P9.0 REVISION: B (AHI REPLACED) #C-1888 H3 PRODUCTION VEHICLE	P8.0 & 8.1 P9.0 & 9.1	R.LAM.	M.J.H.	M.J.H.
D	2011-09-07	#D140380 P 3 , P 4 , P 5 , P 6 Revision B (Front Height control valve Kneeling, Production Vehicle #C-2007...)	P3.0 & 3.1	Rob.	M.J.H.	M.J.H.
	2011-09-07	#D140380 P1 Revision B (update)	P4.0 & 4.1 P5.0 & 5.1 P6.0 & 6.1 P1.0 & 1.1	Rob. Rob. Rob. Rob.	M.J.H. M.J.H. M.J.H. M.J.H.	M.J.H. M.J.H. M.J.H. M.J.H.
E	2011-10-31	#D140380 P 3 , P 4 , P 5 , P 6 Revision C I.F.S. 19,000 LBS Production Vehicle #C-2019	P3.0 & 3.1	Rob.	M.J.H.	M.J.H.
	2011-10-31	#D140380 P1 Revision C (update)	P4.0 & 4.1 P5.0 & 5.1 P6.0 & 6.1 P1.0 & 1.1	Rob. Rob. Rob. Rob.	M.J.H. M.J.H. M.J.H. M.J.H.	M.J.H. M.J.H. M.J.H. M.J.H.

Pneumatic diagram

PNEUMATIC DIAGRAMS H3-45 COACHES WITH INDEPENDENT SUSP.

REV.	DATE	DESCRIPTION	PAGE	BY	CHK.	APPR.
F	2011-11-04	VOLVO ENGINE VERSION WITHOUT DRV VALVE Production vehicle #C-1995...	P8.0 & 9.0	Rob.	M.Pelletier	M.Pelletier
	2011-11-04	#D140380SP2 See new revision : B (Orléans)	P8.1 & 9.1 SP.2 & 2.1	Rob.	M.J.H.	M.J.H.
G	2012-02-05	AIR LOCK ENTRANCE DOOR MODIFICATION Vehicles #C-2054 TO #C-2096 USE PALLIATIVE FITTINGS. SEE SAV. INCLUDED REMOVE PRESSURE SWITCH, OC#2010091 EFF.#C-1903 #D140380 P1 Revision D	P1.0 P1.1 to P1.4	Rob.	M.J.H.	M.J.H.

PREVOST

Pneumatic diagram

PNEUMATIC DIAGRAMS H3-45 COACHES WITH INDEPENDENT SUSP.

PRODUCTION NUMBER	REV	EFF. VEH.	ECN	S.A.V. NUMBER	REV	DESCRIPTION
D140380P1.0	D	# C-2054	2012005	D140380P1.1	D	FULL PNEUMATIC SYSTEM (STANDARD DIAGRAM) ABS 6
				D140380P1.2	D	ACCESSORIES
				D140380P1.3	D	BRAKES SYSTEM
				D140380P1.4	D	SUSPENSION
D140380P2.0	A	# B-1721	2010001	D140380P2.1	A	ESP ELECTRONIC STABILITY PROGRAM OPTION
D140380P3.0	C	# C-2019	2010070	D140380P3.1	C	KNEELING OPTION
D140380P4.0	C	# C-2019	2010070	D140380P4.1	C	KNEELING & LOW-BUOY OPTION
D140380P5.0	C	# C-2019	201070	D140380P5.1	C	KNEELING & HIGH-BUOY OPTION
D140380P6.0	C	# C-2019	2010070	D140380P6.1	C	KNEELING, LOW-BUOY & HIGH-BUOY OPTION
D140380P7.0	A	# B-1721	2010001	D140380P7.1	A	PARKING BRAKE WITH WCL WITHOUT KNEELING OPTION
D140380P8.0	C	#C-1995	2011095	D140380P8.1	C	WITHOUT RETARDER ON ALLISON TRANSM.
D140380P9.0	C	#C-1995	2011095	D140380P9.1	C	WITH RETARDER ON ALLISON TRANSM.
D140380P10.0	B	# B-1721	2010001	D140380P10.1	B	I-SHIFT TRANSMISSION OPTION
D140380P11.0	A	# B-1721	2010001	D140380P11.1	A	I-SHIFT TRANSMISSION & ESP OPTION
D140380P12.0	A	# B-1721	2010001	D140380P12.1	A	HALDEX AIR DRYER
D140380P13.0	A	# B-1721	2010001	D140380P13.1	A	WITH DOOR AIR LOCK, LUGGAGE COMPARTMENT OPTION
D140380SP1.0	A	# B-1721	2010001	D140380SP1.1	A	"SPECIAL" WITH ALLISON TRANSMISSION + ESP AND TRAILER HITCH AIR BRAKE OPTION
D140380SP2.0	B	# C- 1996 # C-2006		D140380SP2.1	B	"SPECIAL" PARKING BRAKE RELEASE WITH SUPPLEMENTARY SWITCH & CUT-OFF AIR SUPPLY TO ENGINE COMPARTMENT ACCESSORIES OPTIONS
D140380SP3.0	A	# B-1721	2010001	D140380SP3.1	A	"SPECIAL" WITH UNLOAD TAG SYSTEM(PITMAN ARM ACTUATED) OPTION
D140380SP4.0	A	# B-1721	2010001	D140380SP4.1	A	"SPECIAL" WITH UNLOAD TAG SYSTEM(PITMAN ARM ACTUATED) OPTION AND ESP OPTION
D140380SP5.0	A	# B-1721	2010001	D140380SP5.1	A	"SPECIAL" WITH INDEPENDENT DOOR AIR LOCK , LUGGAGE COMPARTMENT OPTION
D140380SP6.0	A	# B-1721	2010001	D140380SP6.1	A	REAR AIR FILL VALVE SPECIAL
D140380SP7.0	A	# B-1721	2010001	D140380SP7.1	A	"SPECIAL" WITH WABCO AIR DRYER

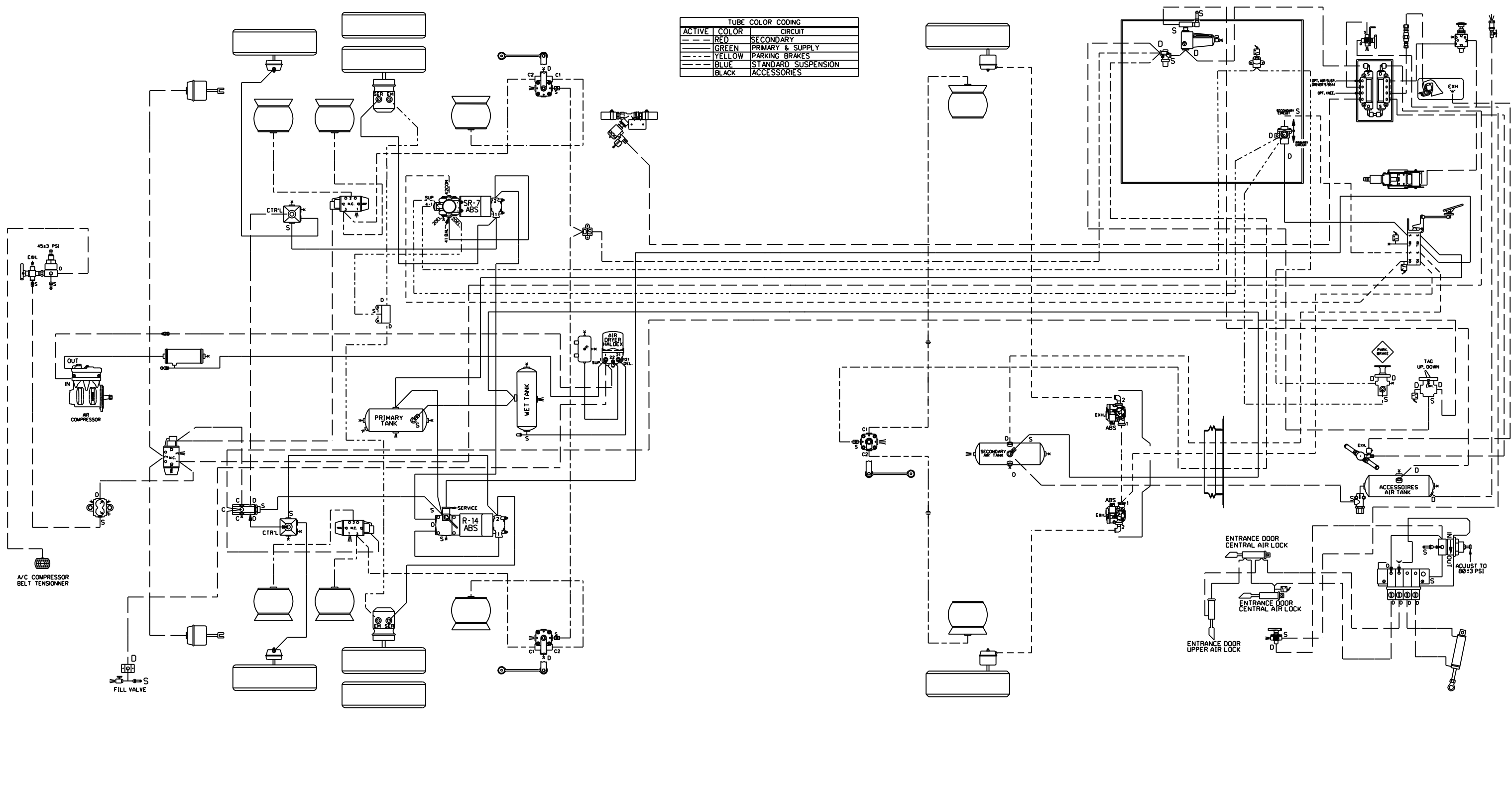

TUBE COLOR CODING	
ACTIVE COLOR	CIRCUIT
RED	SECONDARY
GREEN	PRIMARY & SUPPLY
YELLOW	PARKING BRAKES
BLUE	STANDARD SUSPENSION
BLACK	ACCESSORIES

PREVOST

DESCRIPTION:
 H3-45 COACHES
 WITH INDEPENDENT FRONT SUSPENSION (I.F.S.)
 FULL PNEUMATIC SYSTEM

REV: C
 DATE: 2011/10

PAGE:
 D140380 P.1

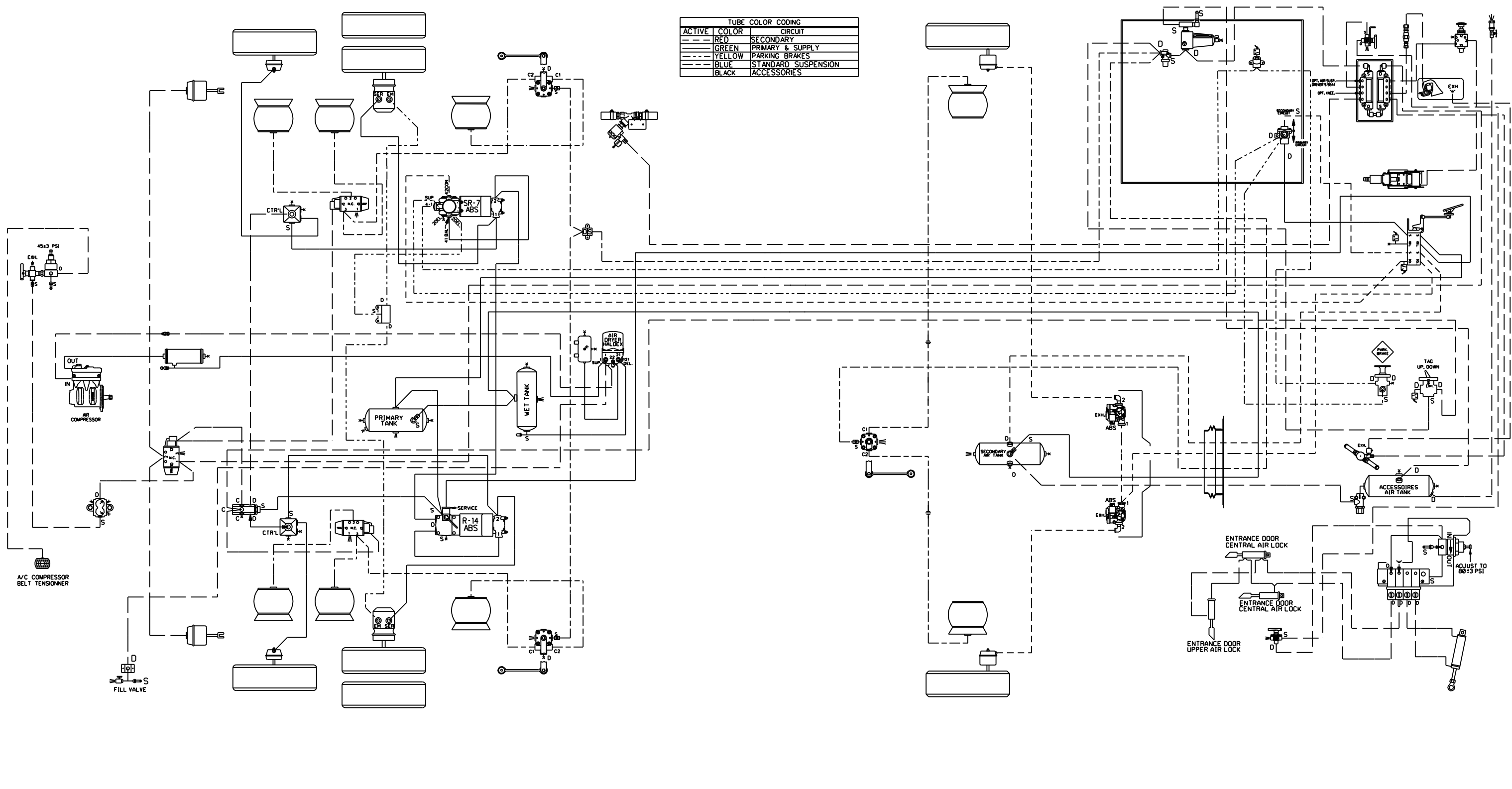

ACTIVE	COLOR	CIRCUIT
---	RED	SECONDARY
---	GREEN	PRIMARY & SUPPLY
---	YELLOW	PARKING BRAKES
---	BLUE	STANDARD SUSPENSION
---	BLACK	ACCESSORIES

PREVOST

DESCRIPTION: H3-45 COACHES
WITH INDEPENDENT FRONT SUSPENSION (I.F.S.)
FULL PNEUMATIC SYSTEM

REV: D
DATE: 2012/02

PAGE: D140380 P.1

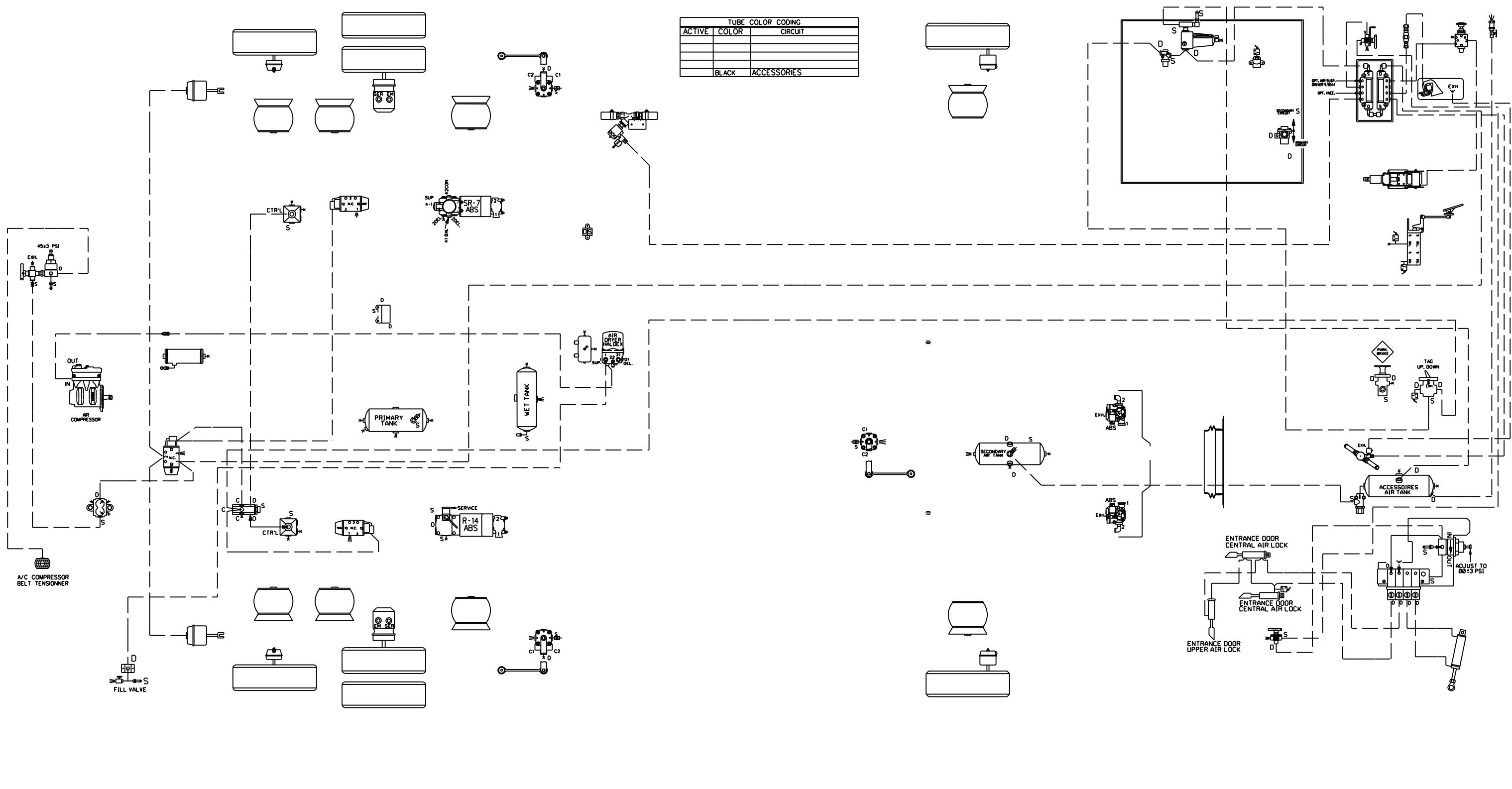

PREVOST

DESCRIPTION:
 H3-45 COACHES
 WITH INDEPENDENT FRONT SUSPENSION (I.F.S.)
 ACCESSORIES

REV.: C
 DATE: 2011/10

PAGE:
 D140380P1.2

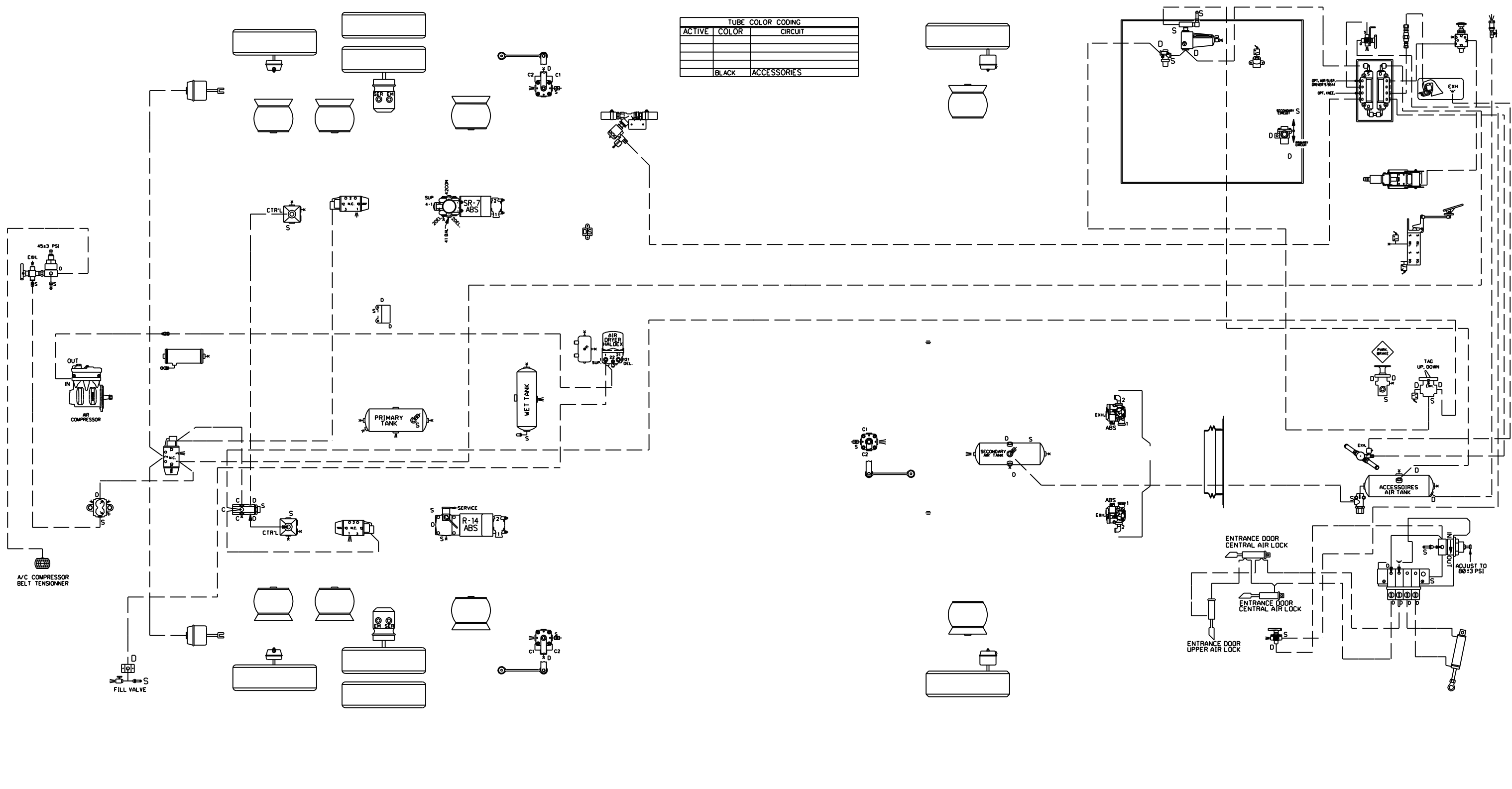

PREVOST

DESCRIPTION:
 H3-45 COACHES
 WITH INDEPENDENT FRONT SUSPENSION (I.F.S.)
 ACCESSORIES

REV.: D
 DATE: 2012/02

PAGE:
 D140380P1.2

TUBE COLOR CODING	
ACTIVE COLOR	CIRCUIT
---	RED SECONDARY
---	GREEN PRIMARY & SUPPLY
---	YELLOW PARKING BRAKES

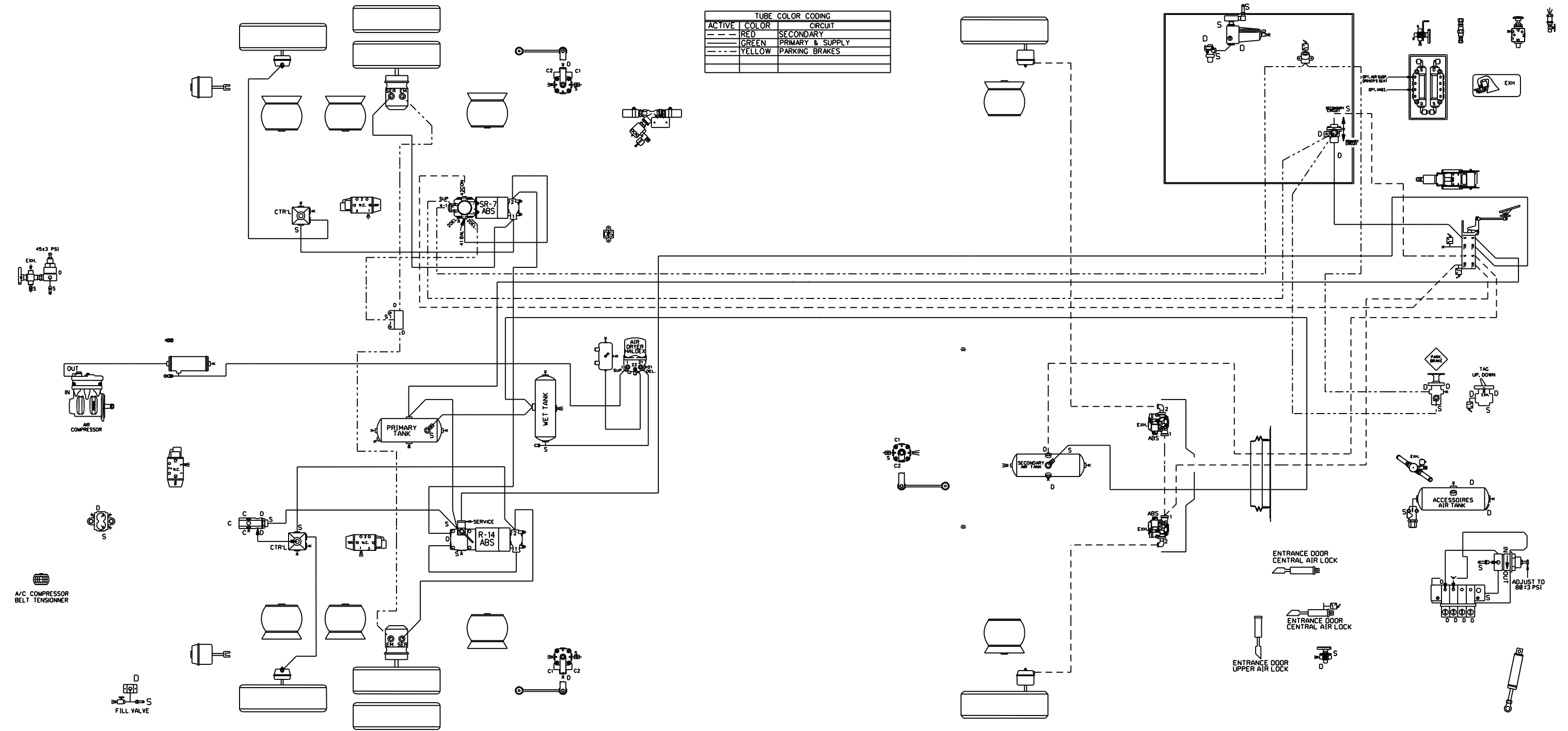

PREVOST

DESCRIPTION:
 H3-45 COACHES
 WITH INDEPENDENT FRONT SUSPENSION (I.F.S.)
 BRAKES SYSTEM

REV: C
 DATE: 2011/10

PAGE:
 D140380 P1.3

TUBE COLOR CODING		
ACTIVE	COLOR	CIRCUIT
---	BLUE	STANDARD SUSPENSION

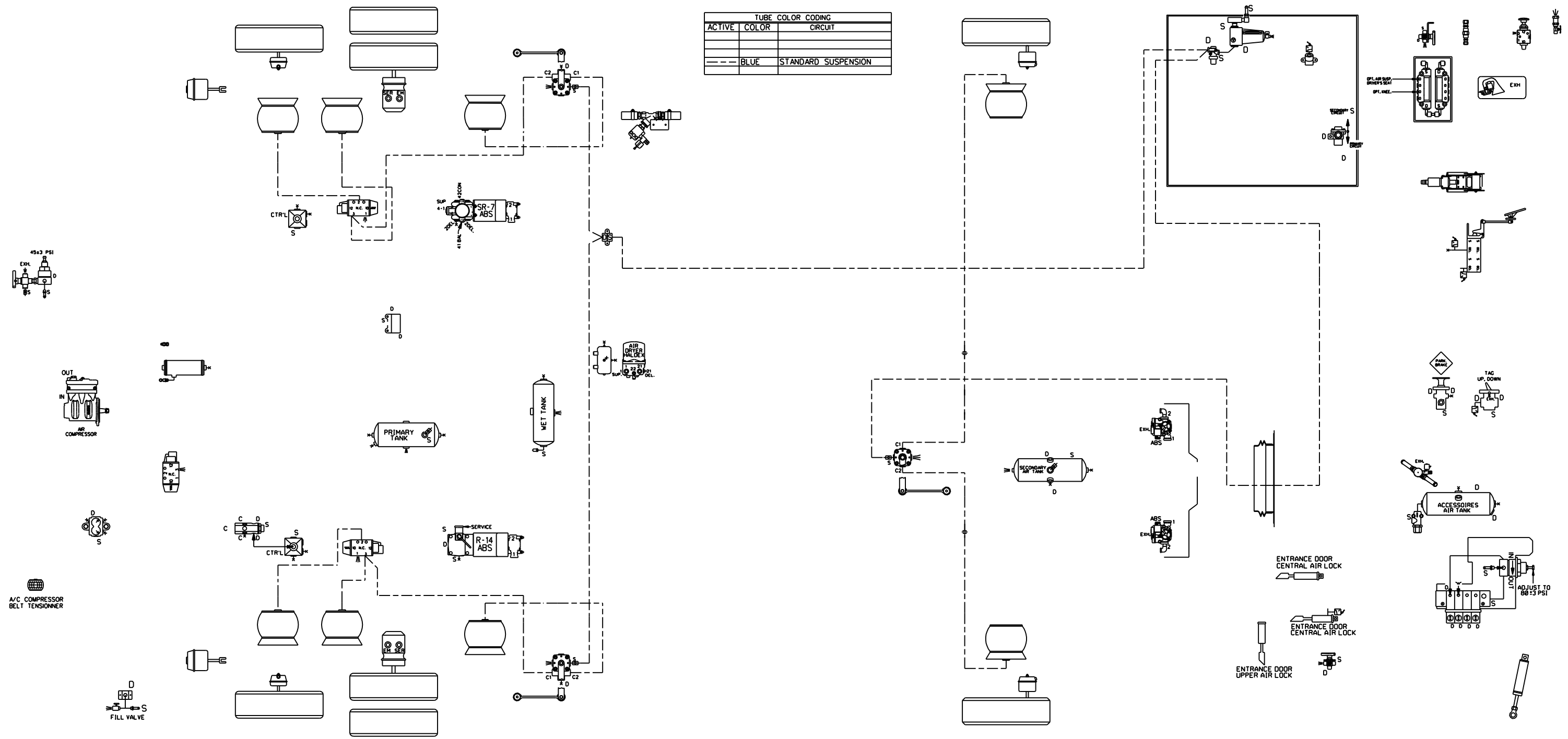

PREVOST

DESCRIPTION:

H3-45 COACHES
WITH INDEPENDENT FRONT SUSPENSION (I.F.S.)
STANDARD SUSPENSION

REV.:

C

PAGE:

DATE:

2011/10

D140380 P1.4

TUBE COLOR CODING		
ACTIVE	COLOR	CIRCUIT
---	BLUE	STANDARD SUSPENSION

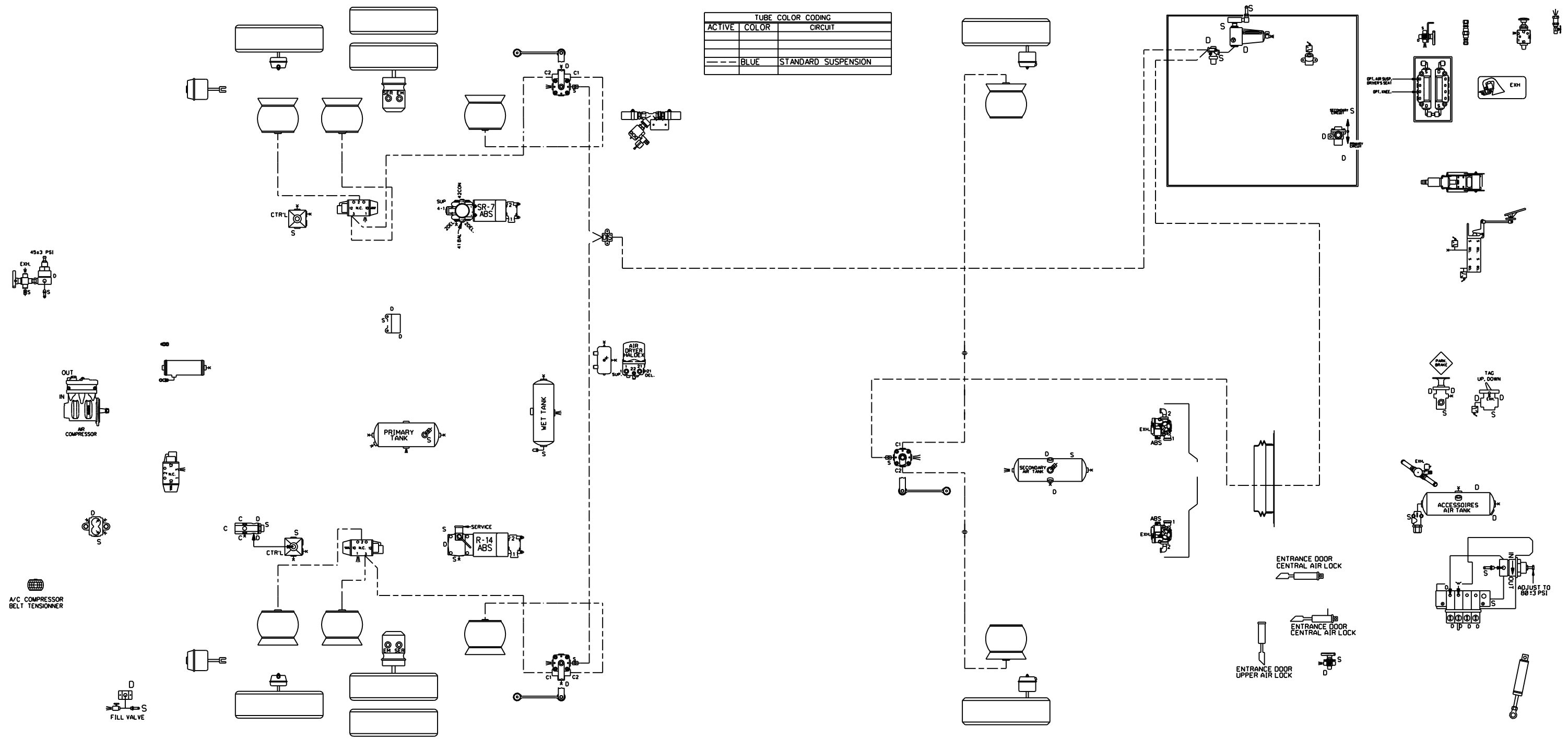

PREVOST

DESCRIPTION:

H3-45 COACHES
WITH INDEPENDENT FRONT SUSPENSION (I.F.S.)
STANDARD SUSPENSION

REV.: D
DATE: 2012/02

PAGE:
D140380 P1.4

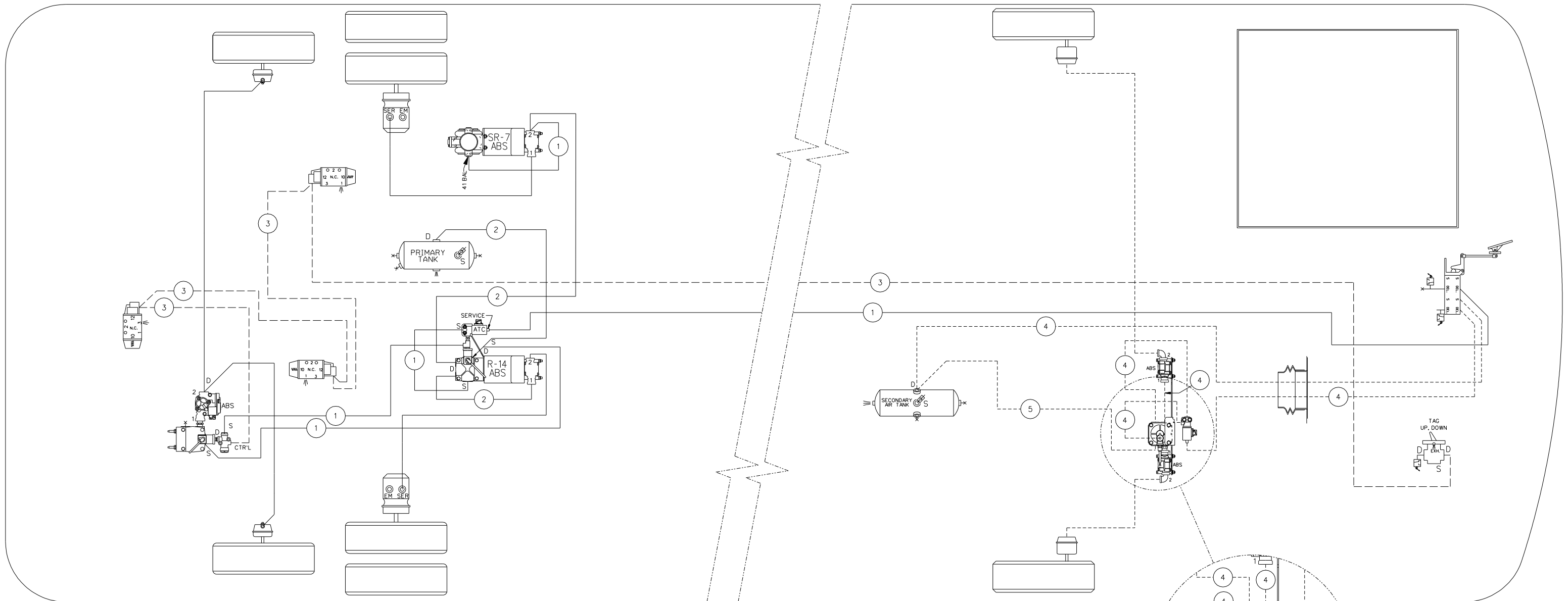

BALLOON	PIPE
#1	3/8" O.D. GREEN
#2	5/8" O.D. GREEN
#3	1/4" O.D. BLACK
#4	1/2" O.D. RED
#5	5/8" O.D. RED

TUBE COLOR CODING		
ACTIVE	COLOR	CIRCUIT
—	GREEN	PRIMARY & SUPPLY
- - -	BLACK	ACCESSORIES
- - - -	RED	SECONDARY

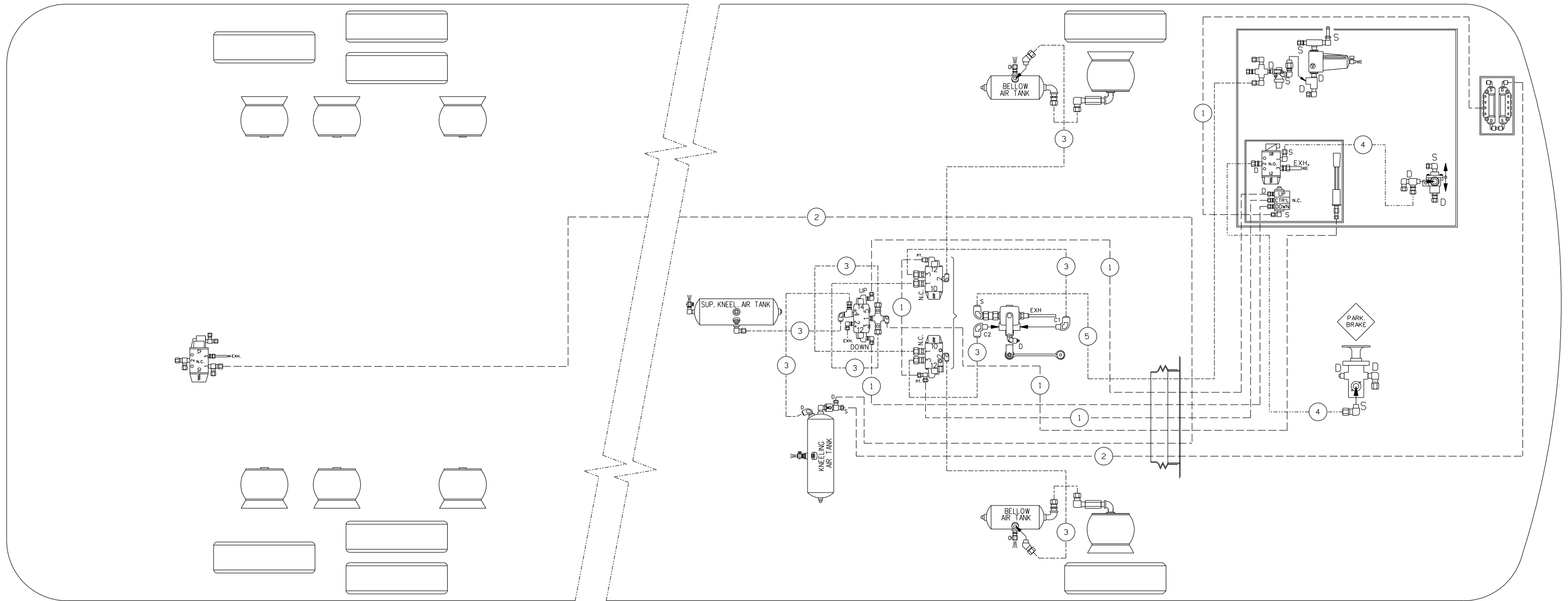

TUBE COLOR CODING		
ACTIVE	COLOR	CIRCUIT
---	YELLOW	PARKING BRAKE
---	BLACK	ACCESSORIES
---	BLUE	KNEELING OPTION

BALLOON	PIPE
#1	1/4" O.D. BLACK
#2	3/8" O.D. BLACK
#3	1/2" O.D. BLUE
#4	3/8" O.D. YELLOW
#5	3/8" O.D. BLUE

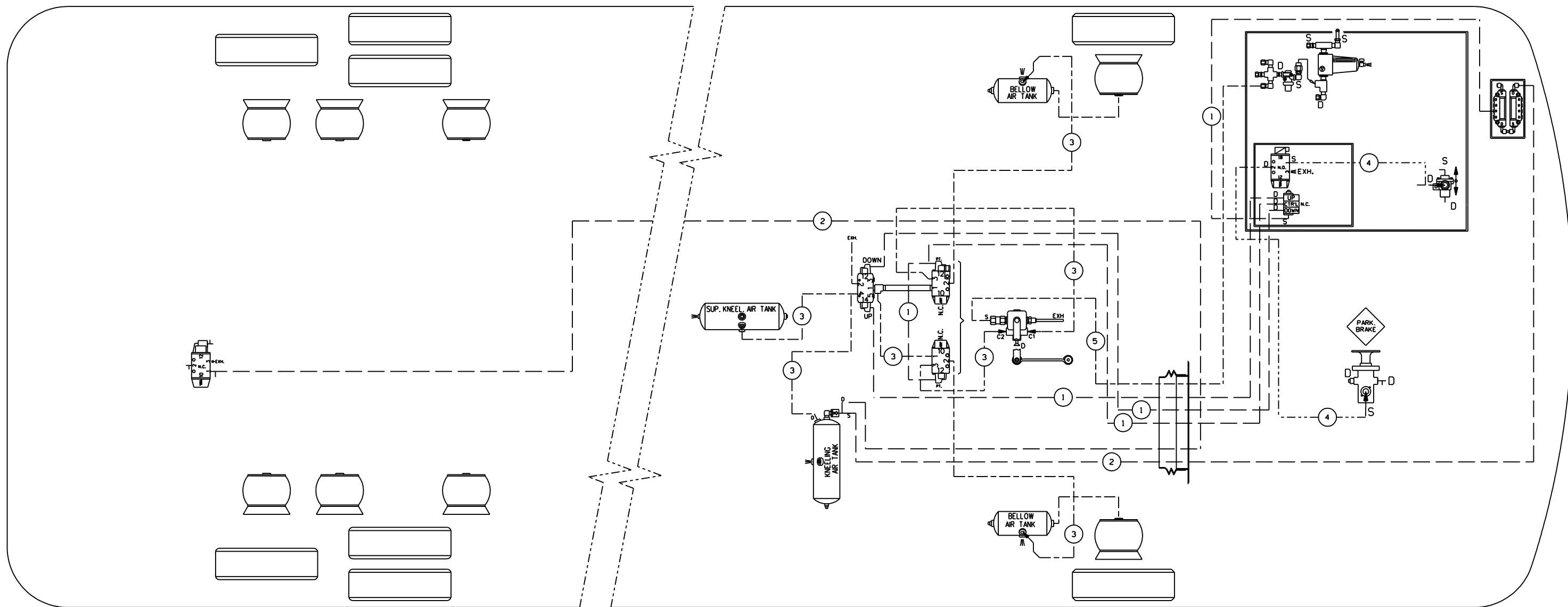

TUBE COLOR CODING		
ACTIVE	COLOR	CIRCUIT
---	YELLOW	PARKING BRAKE
---	BLACK	ACCESSORIES
---	BLUE	KNEELING OPTION

BALLOON	PIPE
#1	1/4" O.D. BLACK
#2	3/8" O.D. BLACK
#3	1/2" O.D. BLUE
#4	3/8" O.D. YELLOW
#5	3/8" O.D. BLUE

PREVOST®

DESCRIPTION:

H3-45 COACHES,
WITH INDEPENDENT FRONT SUSPENSION (I.F.S.)
WITH FRONT KNEELING OPTION

REV.:

B

PAGE:

DATE:

2011/09

D140380 P3.1

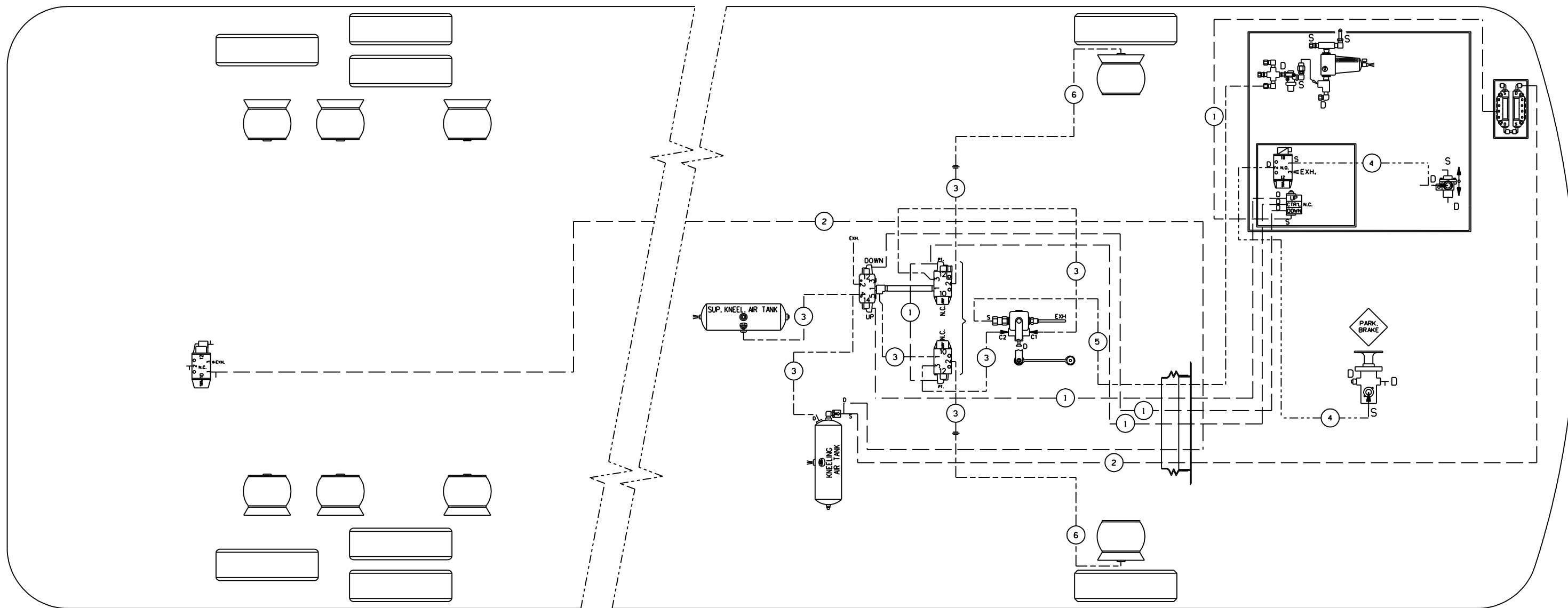

TUBE COLOR CODING		
ACTIVE	COLOR	CIRCUIT
---	YELLOW	PARKING BRAKE
---	BLACK	ACCESSORIES
---	BLUE	KNEELING OPTION

BALLOON	PIPE
#1	1/4" O.D. BLACK
#2	3/8" O.D. BLACK
#3	1/2" O.D. BLUE
#4	3/8" O.D. YELLOW
#5	3/8" O.D. BLUE
#6	HOSE ASSY #8

PREVOST®

DESCRIPTION:

H3-45 COACHES,
WITH INDEPENDENT FRONT SUSPENSION (I.F.S.)
WITH FRONT KNEELING OPTION

REV.:

C

DATE:

2011/10

PAGE:

D140380 P3.1

TUBE COLOR CODING	
ACTIVE COLOR	CIRCUIT
---	RED SECONDARY
---	GREEN PRIMARY & SUPPLY
---	YELLOW PARKING BRAKES

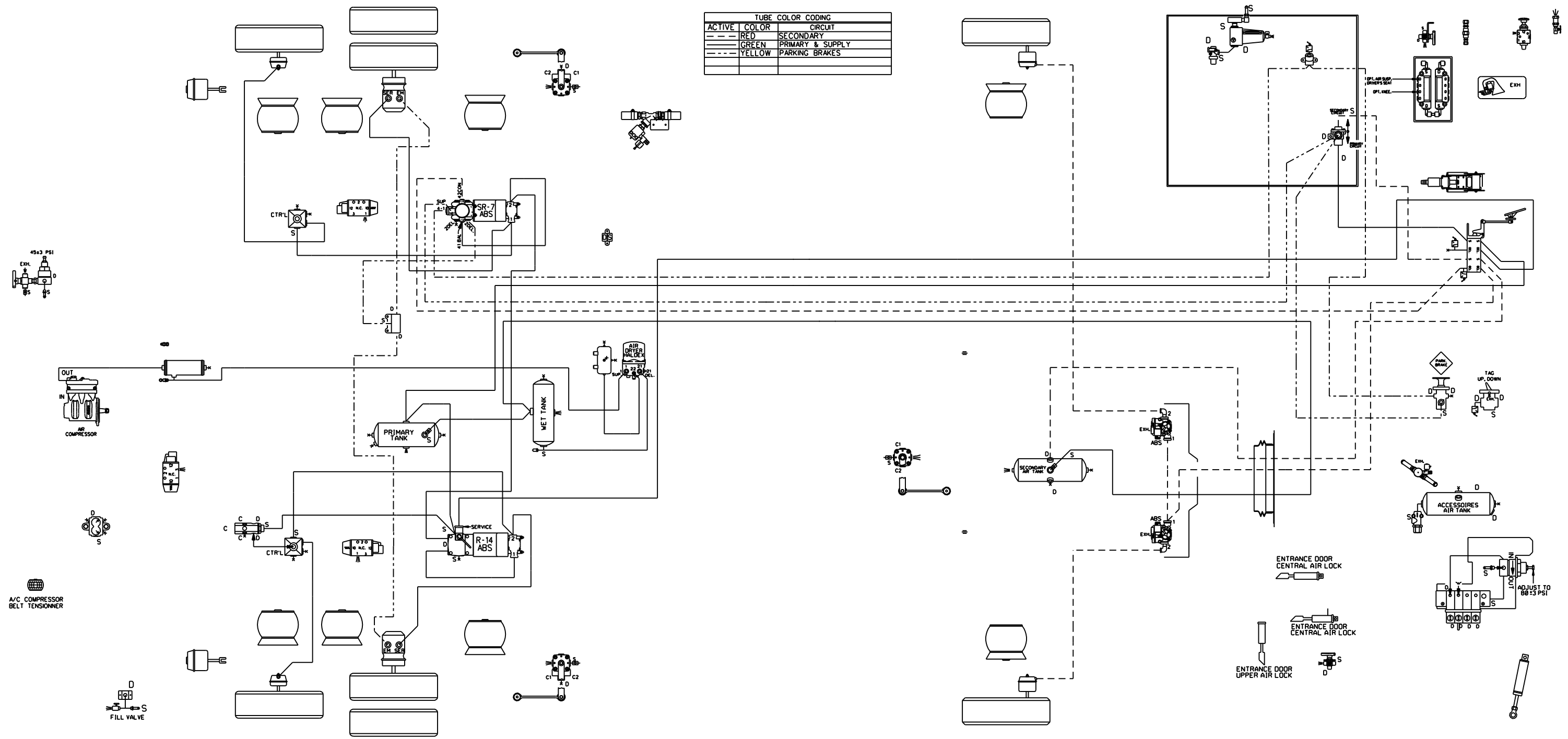

PREVOST

DESCRIPTION: H3-45 COACHES WITH INDEPENDENT FRONT SUSPENSION (I.F.S.) BRAKES SYSTEM

REV.: D
DATE: 2012/02

PAGE: D140380 P1.3

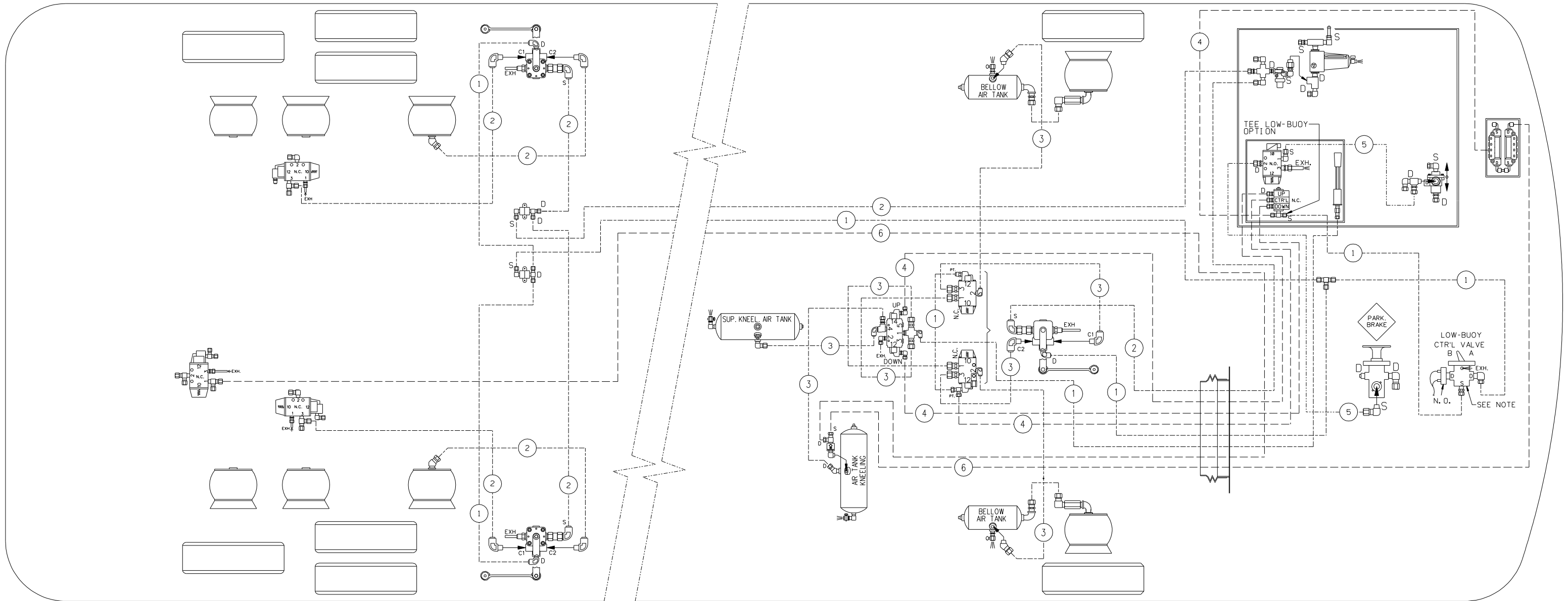

TUBE COLOR CODING		
ACTIVE	COLOR	CIRCUIT
---	YELLOW	PARKING BRAKE
---	BLACK	ACCESSORIES
---	BLUE	KNEELING OPTION

CONTROL VALVE OPT. "LOW-BUOY" , "A" OR "B" SETTING:

POSITION "A": VALVE IS OPEN,
AIR FLOW BETWEEN SUPPLY (S) AND
DELIVERY (D) , LOW-BUOY IS IN FUNCTION.

POSITION "B": VALVE CLOSED,
AIR DOES'NT FLOW BETWEEN SUPPLY (S) AND
DELIVERY (D) , LOW-BUOY IS NOT IN FUNCTION.

BALLOON	PIPE
*1	1/4" O.D. BLUE
*2	3/8" O.D. BLUE
*3	1/2" O.D. BLUE
*4	1/4" O.D. BLACK
*5	3/8" O.D. YELLOW
*6	3/8" O.D. BLACK

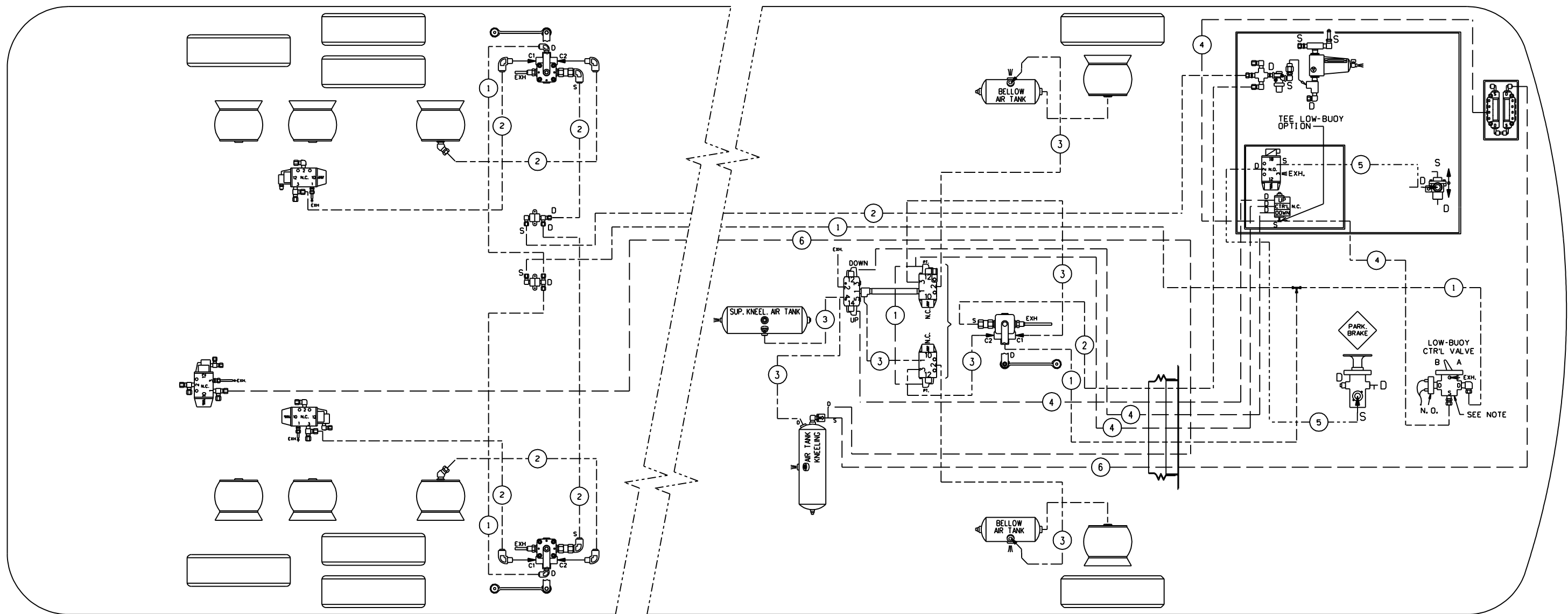

TUBE COLOR CODING		
ACTIVE	COLOR	CIRCUIT
---	YELLOW	PARKING BRAKE
---	BLACK	ACCESSORIES
---	BLUE	KNEELING OPTION

CONTROL VALVE OPT. "LOW-BUOY" , "A" OR "B" SETTING:

POSITION "A": VALVE IS OPEN,
AIR FLOW BETWEEN SUPPLY (S) AND
DELIVERY (D) , LOW-BUOY IS IN FUNCTION.

POSITION "B": VALVE CLOSED,
AIR DOES'NT FLOW BETWEEN SUPPLY (S) AND
DELIVERY (D) , LOW-BUOY IS NOT IN FUNCTION.

BALLOON	PIPE
*1	1/4" O.D. BLUE
*2	3/8" O.D. BLUE
*3	1/2" O.D. BLUE
*4	1/4" O.D. BLACK
*5	3/8" O.D. YELLOW
*6	3/8" O.D. BLACK

PREVOST®

DESCRIPTION:

H3-45 COACHES,
WITH INDEPENDENT FRONT SUSPENSION (I.F.S.)
WITH KNEELING AND LOW-BUOY OPTION

REV.:

B

PAGE:

D140380 P4.1

DATE:

2011/09

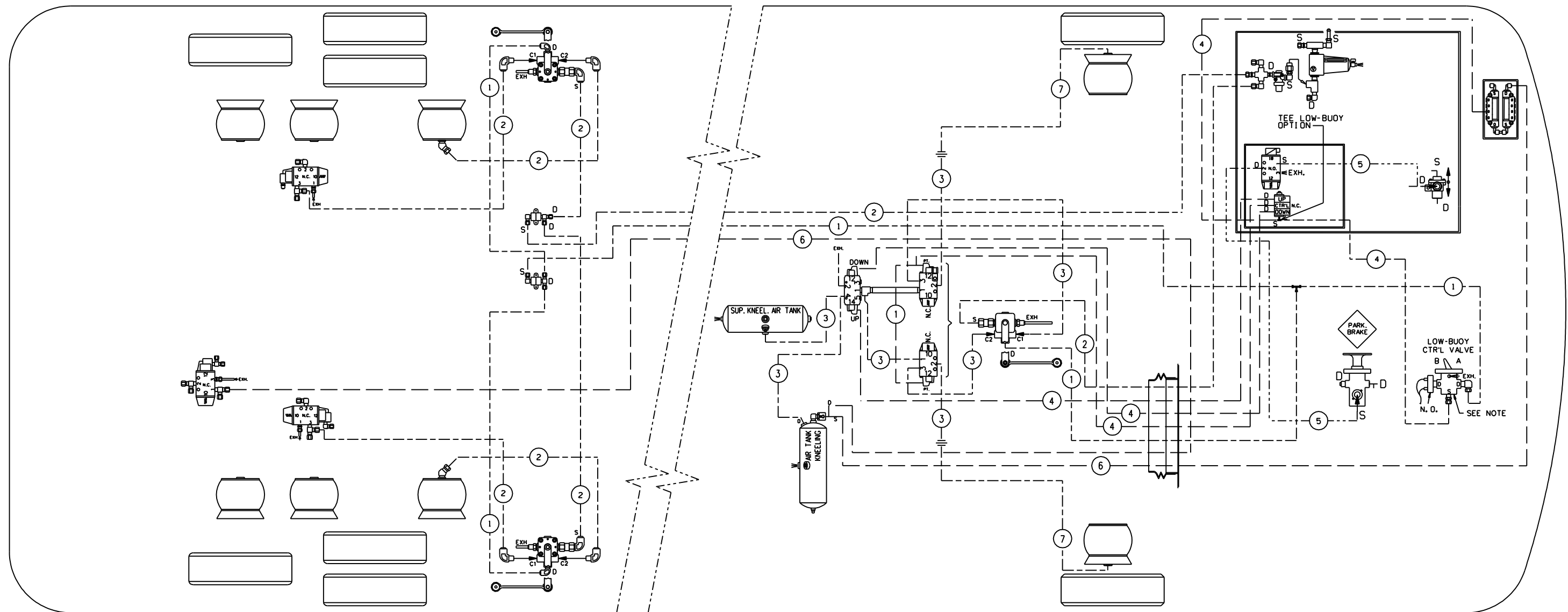

TUBE COLOR CODING		
ACTIVE	COLOR	CIRCUIT
---	YELLOW	PARKING BRAKE
---	BLACK	ACCESSORIES
---	BLUE	KNEELING OPTION

CONTROL VALVE OPT. "LOW-BUOY" , "A" OR "B" SETTING:

POSITION "A": VALVE IS OPEN,
AIR FLOW BETWEEN SUPPLY (S) AND
DELIVERY (D) , LOW-BUOY IS IN FUNCTION.

POSITION "B": VALVE CLOSED,
AIR DOES'NT FLOW BETWEEN SUPPLY (S) AND
DELIVERY (D) , LOW-BUOY IS NOT IN FUNCTION.

BALLOON	PIPE
*1	1/4" O.D. BLUE
*2	3/8" O.D. BLUE
*3	1/2" O.D. BLUE
*4	1/4" O.D. BLACK
*5	3/8" O.D. YELLOW
*6	3/8" O.D. BLACK
*7	HOSE ASSY
*8	

PREVOST®

DESCRIPTION:

H3-45 COACHES,
WITH INDEPENDENT FRONT SUSPENSION (I.F.S.)
WITH KNEELING AND LOW-BUOY OPTION

REV.:

C

DATE:

2011/10

PAGE:

D140380 P4.1

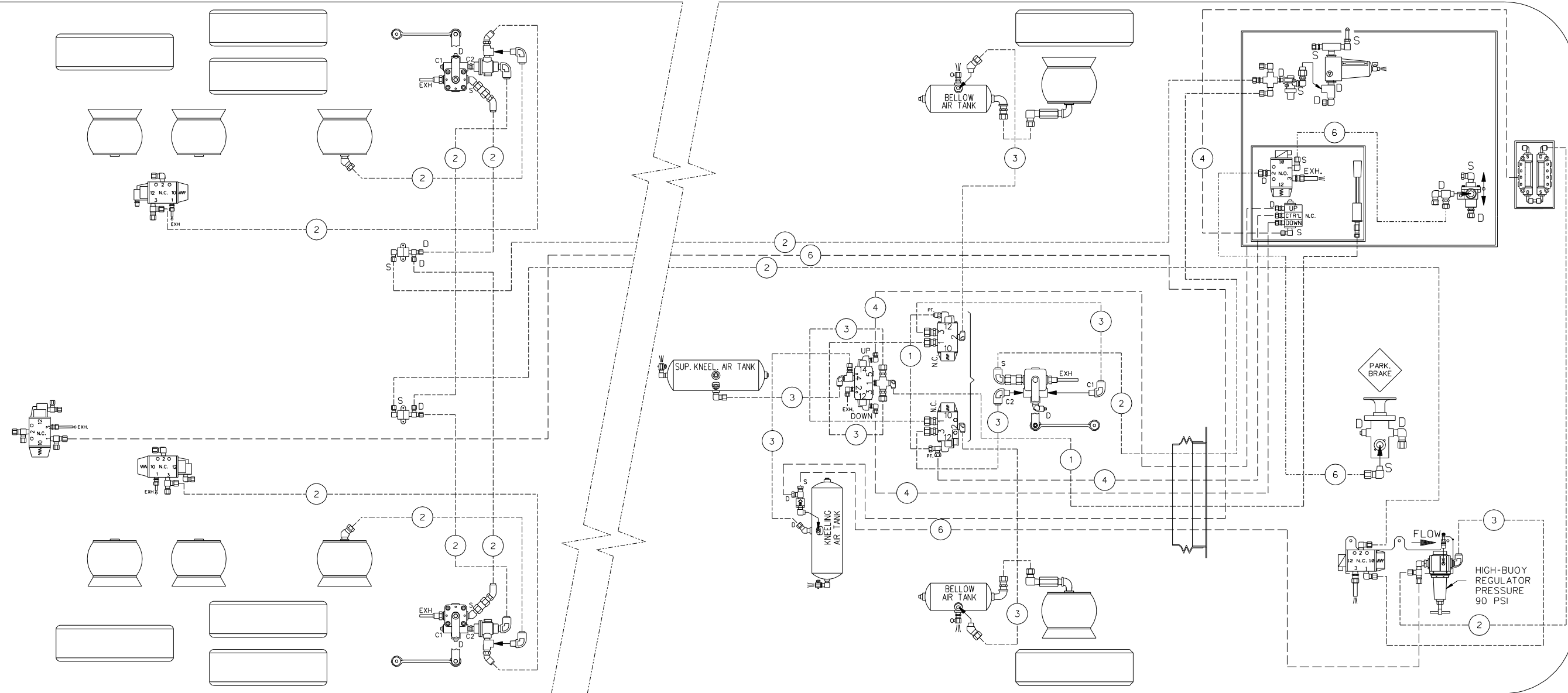

TUBE COLOR CODING		
ACTIVE	COLOR	CIRCUIT
- - - - -	YELLOW	PARKING BRAKE
- - - - -	BLACK	ACCESSORIES
- - - - -	BLUE	KNEELING OPTION

BALLOON	PIPE
#1	1/4" O.D. BLUE
#2	3/8" O.D. BLUE
#3	1/2" O.D. BLUE
#4	1/4" O.D. BLACK
#5	3/8" O.D. YELLOW
#6	3/8" O.D. BLACK

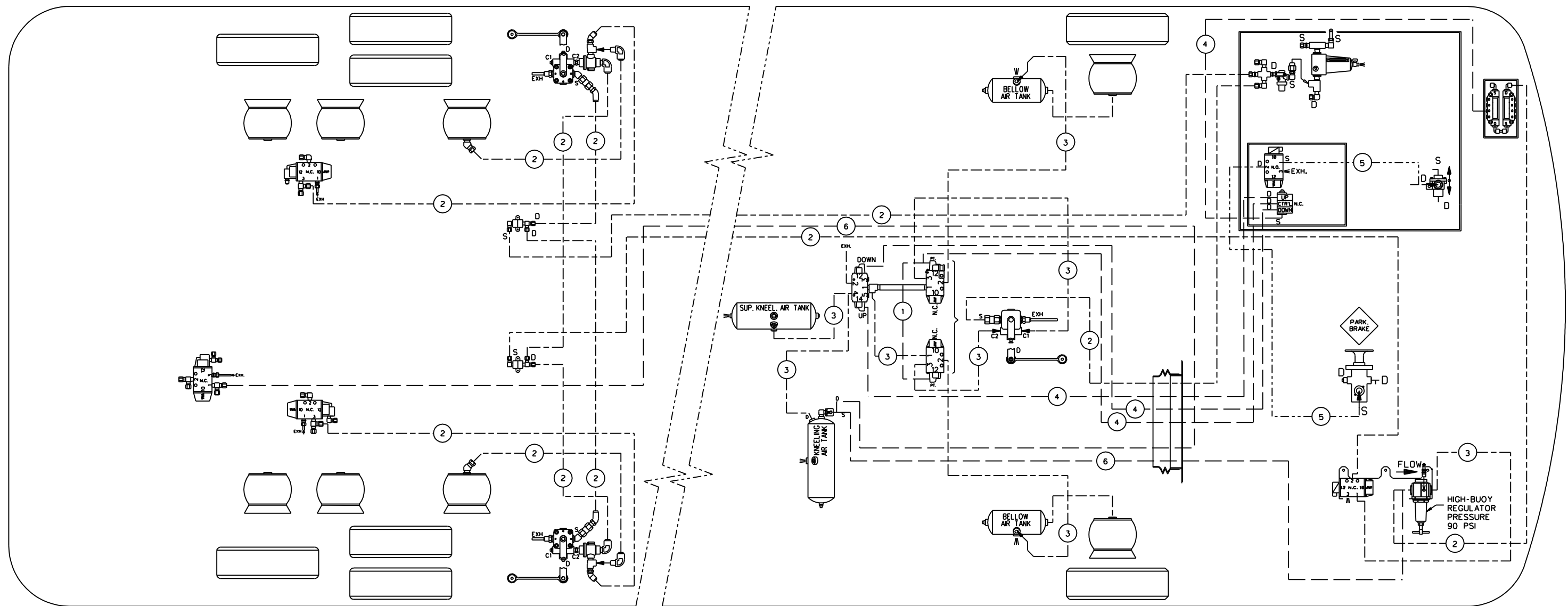

TUBE COLOR CODING	
ACTIVE	COLOR
---	YELLOW
---	BLACK
---	BLUE
---	---
CIRCUIT	
---	PARKING BRAKE
---	ACCESSORIES
---	KNEELING OPTION

BALLOON	PIPE
#1	1/4" O.D. BLUE
#2	3/8" O.D. BLUE
#3	1/2" O.D. BLUE
#4	1/4" O.D. BLACK
#5	3/8" O.D. YELLOW
#6	3/8" O.D. BLACK

PREVOST®

DESCRIPTION:

H3-45 COACHES,
WITH INDEPENDENT FRONT SUSPENSION (I.F.S.)
WITH FRONT KNEELING AND HIGH-BUOY
COMBINATION OPTION

REV.:

B

DATE:

2011/09

PAGE:

D140380 P5.1

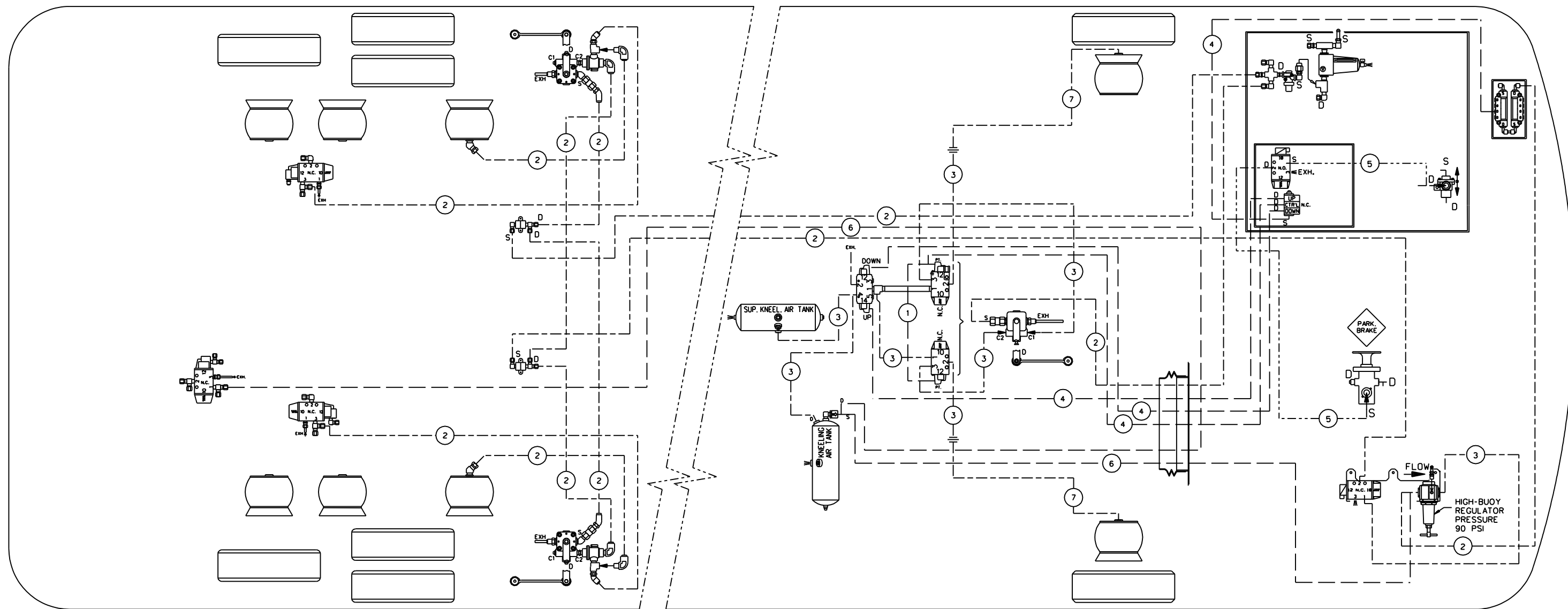

TUBE COLOR CODING	
ACTIVE COLOR	CIRCUIT
---	YELLOW PARKING BRAKE
---	BLACK ACCESSORIES
---	BLUE KNEELING OPTION

BALLOON	PIPE
#1	1/4" O.D. BLUE
#2	3/8" O.D. BLUE
#3	1/2" O.D. BLUE
#4	1/4" O.D. BLACK
#5	3/8" O.D. YELLOW
#6	3/8" O.D. BLACK
#7	HOSE ASS. #8

PREVOST®

DESCRIPTION:

H3-45 COACHES,
WITH INDEPENDENT FRONT SUSPENSION (I.F.S.)
WITH FRONT KNEELING AND HIGH-BUOY
COMBINATION OPTION

REV.:

C

PAGE:

D140380 P5.1

DATE:

2011/10

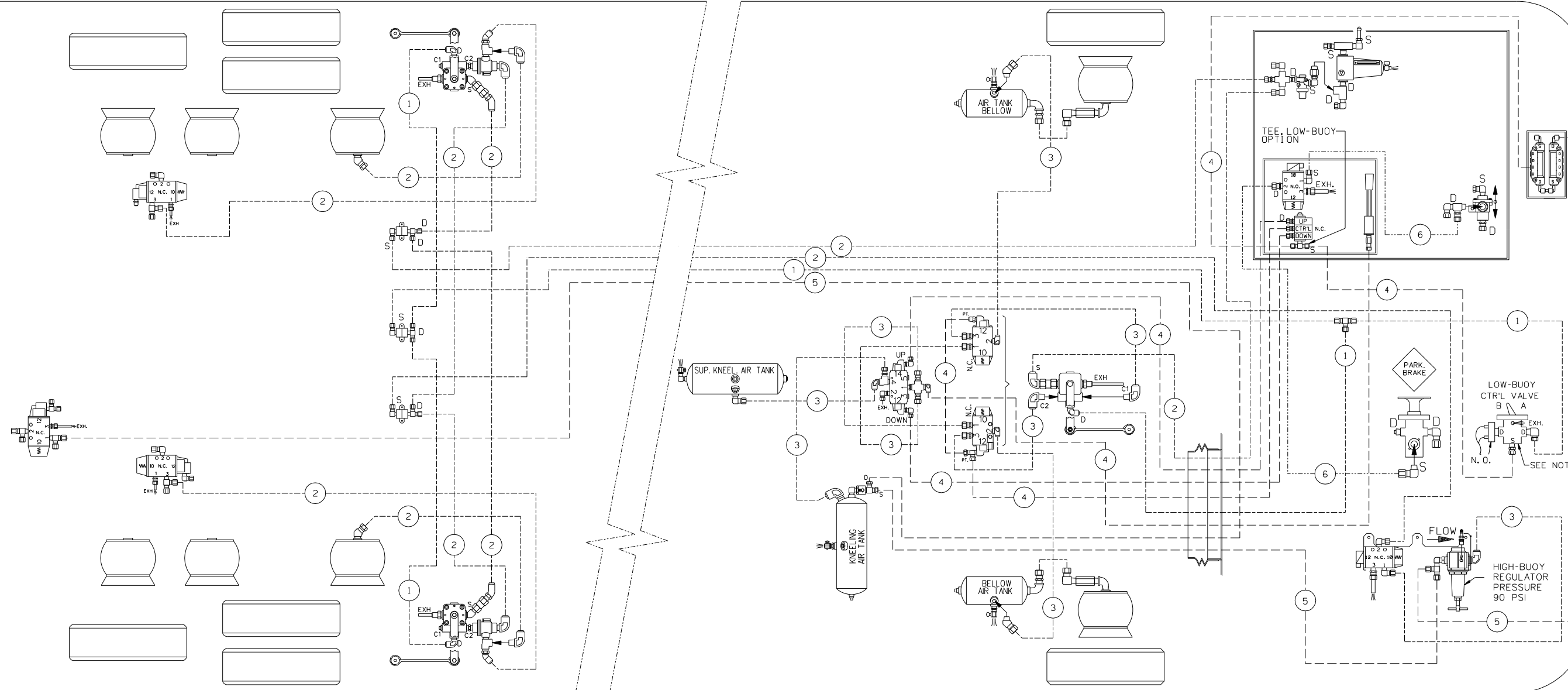

TUBE COLOR CODING		
ACTIVE	COLOR	CIRCUIT
---	YELLOW	PARKING BRAKE
---	BLACK	ACCESSORIES
---	BLUE	SUSPENSION OPTION

CONTROL VALVE OPT. "LOW-BUOY" , "A" OR "B" SETTING:

POSITION "A": VALVE IS OPEN,
AIR FLOW BETWEEN SUPPLY (S) AND
DELIVERY (D) , LOW-BUOY IS IN FUNCTION.

POSITION "B": VALVE CLOSED,
AIR DOES'NT FLOW BETWEEN SUPPLY (S) AND
DELIVERY (D) , LOW-BUOY IS NOT IN FUNCTION.

BALLOON	PIPE
#1	1/4" O.D. BLUE
#2	3/8" O.D. BLUE
#3	1/2" O.D. BLUE
#4	1/4" O.D. BLACK
#5	3/8" O.D. BLACK
#6	3/8" O.D. YELLOW

PREVOST®

DESCRIPTION:

H3-45 COACHES,
WITH INDEPENDENT FRONT SUSPENSION (I.F.S.)
WITH KNEELING, LOW-BUOY & HIGH-COMBINATION

REV.:
A
DATE: 2010/09

PAGE:
D140380 P6.1

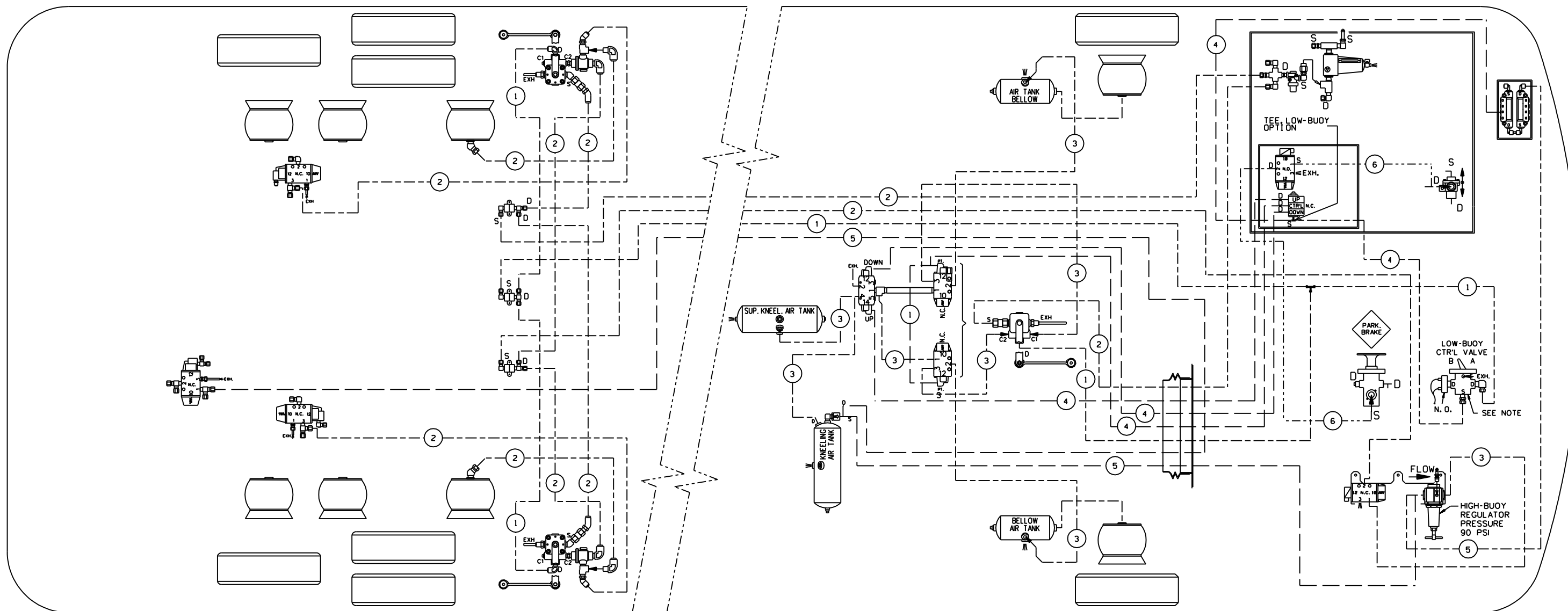

TUBE COLOR CODING	
ACTIVE COLOR	CIRCUIT
---	YELLOW PARKING BRAKE
---	BLACK ACCESSORIES
---	BLUE SUSPENSION OPTION

NOTE :
CONTROL VALVE OPT. "LOW-BUOY" , "A" OR "B" SETTING:

POSITION "A": VALVE IS OPEN,
AIR FLOW BETWEEN SUPPLY (S) AND
DELIVERY (D) , LOW-BUOY IS IN FUNCTION.

POSITION "B": VALVE CLOSED,
AIR DOES'NT FLOW BETWEEN SUPPLY (S) AND
DELIVERY (D) , LOW-BUOY IS NOT IN FUNCTION.

BALLOON	PIPE
•1	1/4" O.D. BLUE
•2	3/8" O.D. BLUE
•3	1/2" O.D. BLUE
•4	1/4" O.D. BLACK
•5	3/8" O.D. BLACK
•6	3/8" O.D. YELLOW

PREVOST®

DESCRIPTION:

H3-45 COACHES,
WITH INDEPENDENT FRONT SUSPENSION (I.F.S.)
WITH KNEELING, LOW-BUOY & HIGH-COMBINATION

REV.:

B

DATE:

2011/09

PAGE:

D140380 P6.1

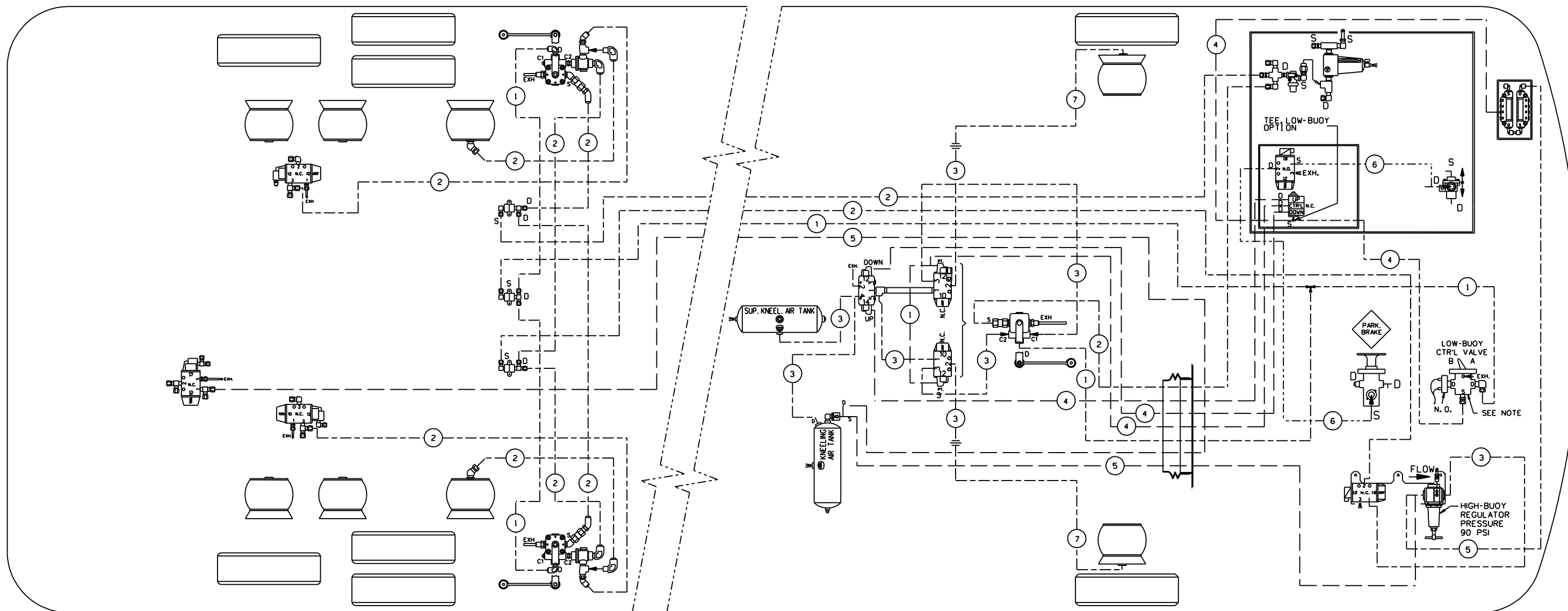

TUBE COLOR CODING	
ACTIVE COLOR	CIRCUIT
---	YELLOW PARKING BRAKE
---	BLACK ACCESSORIES
---	BLUE SUSPENSION OPTION

NOTE :
CONTROL VALVE OPT. "LOW-BUOY" , "A" OR "B" SETTING:

POSITION "A": VALVE IS OPEN,
AIR FLOW BETWEEN SUPPLY (S) AND
DELIVERY (D) , LOW-BUOY IS IN FUNCTION.

POSITION "B": VALVE CLOSED,
AIR DOES'NT FLOW BETWEEN SUPPLY (S) AND
DELIVERY (D) , LOW-BUOY IS NOT IN FUNCTION.

BALLOON	PIPE
•1	1/4" O.D. BLUE
•2	3/8" O.D. BLUE
•3	1/2" O.D. BLUE
•4	1/4" O.D. BLACK
•5	3/8" O.D. BLACK
•6	3/8" O.D. YELLOW
•7	HOSE ASS. #8

PREVOST®

DESCRIPTION: H3-45 COACHES,
WITH INDEPENDENT FRONT SUSPENSION (I.F.S.)
WITH KNEELING, LOW-BUOY & HIGH-COMBINATION

REV.: C
DATE: 2011/10

PAGE: D140380 P6.1

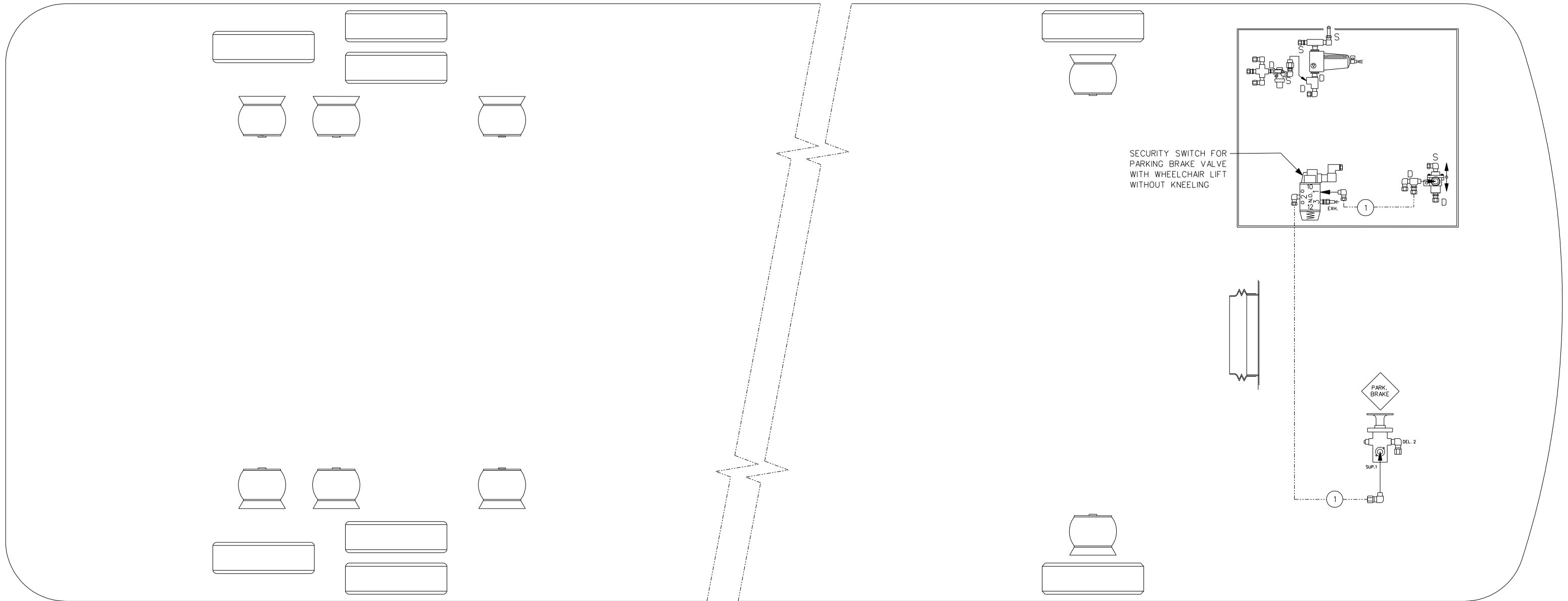

TUBE COLOR CODING		
ACTIVE	COLOR	CIRCUIT
---	YELLOW	PARKING BRAKE

BALLOON	PIPE
#1	3/8" O.D. YELLOW

PREVOST®

DESCRIPTION:
 H3-45 COACHES WITH INDEPENDENT FRONT SUSPENSION (I.F.S.)
 WITH PARKING BRAKE OPTION WITH WHEELCHAIR LIFT AND WITHOUT KNEELING

REV.: A
 DATE: 2010/09

PAGE:
 D140380 P7.1

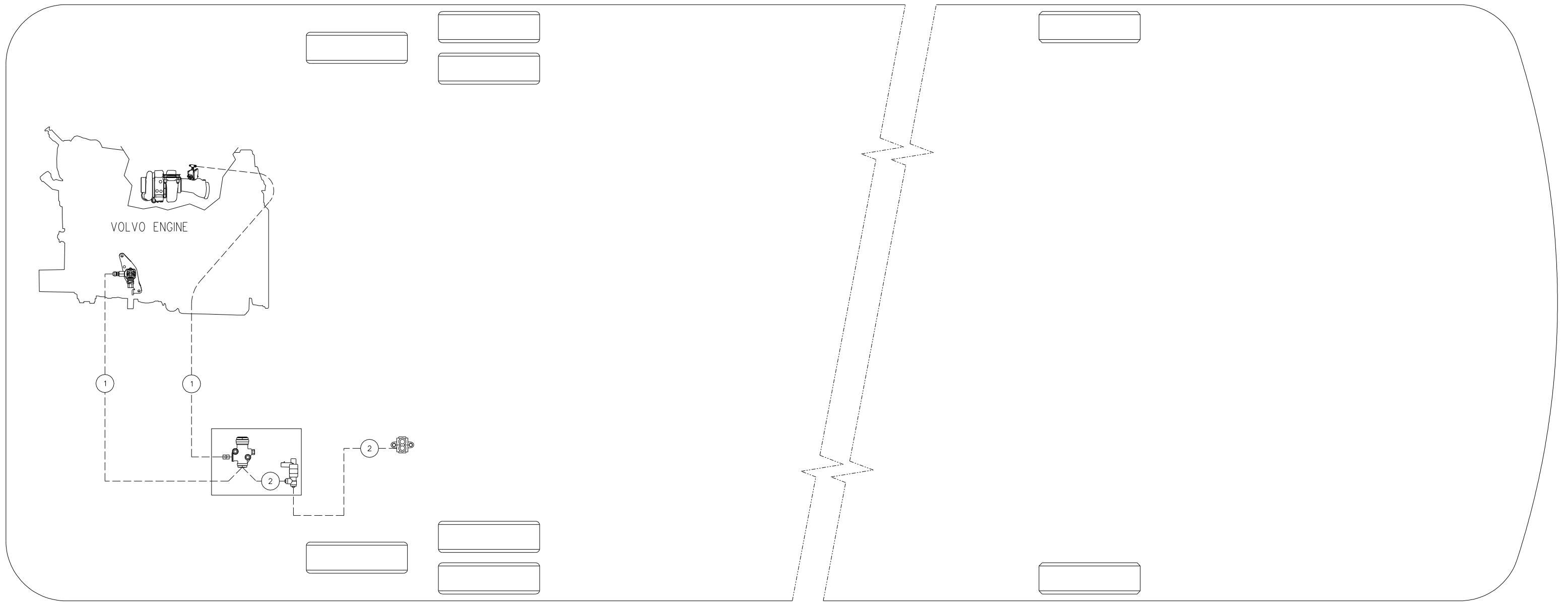

TUBE COLOR CODING		
ACTIVE	COLOR	CIRCUIT
-----	BLACK	ACCESSORIES

BALLOON	PIPE
#1	HOSE ASS'Y
#2	1/4" O.D. BLACK

PREVOST®

DESCRIPTION: H3-45 COACHES, WITH INDEPENDENT FRONT SUSPENSION (I.F.S.),
WITHOUT
OUTPUT RETARDER ON WORLD TRANSMISSION

REV.: A
DATE: 2010/09

PAGE:
D140380 P8.1

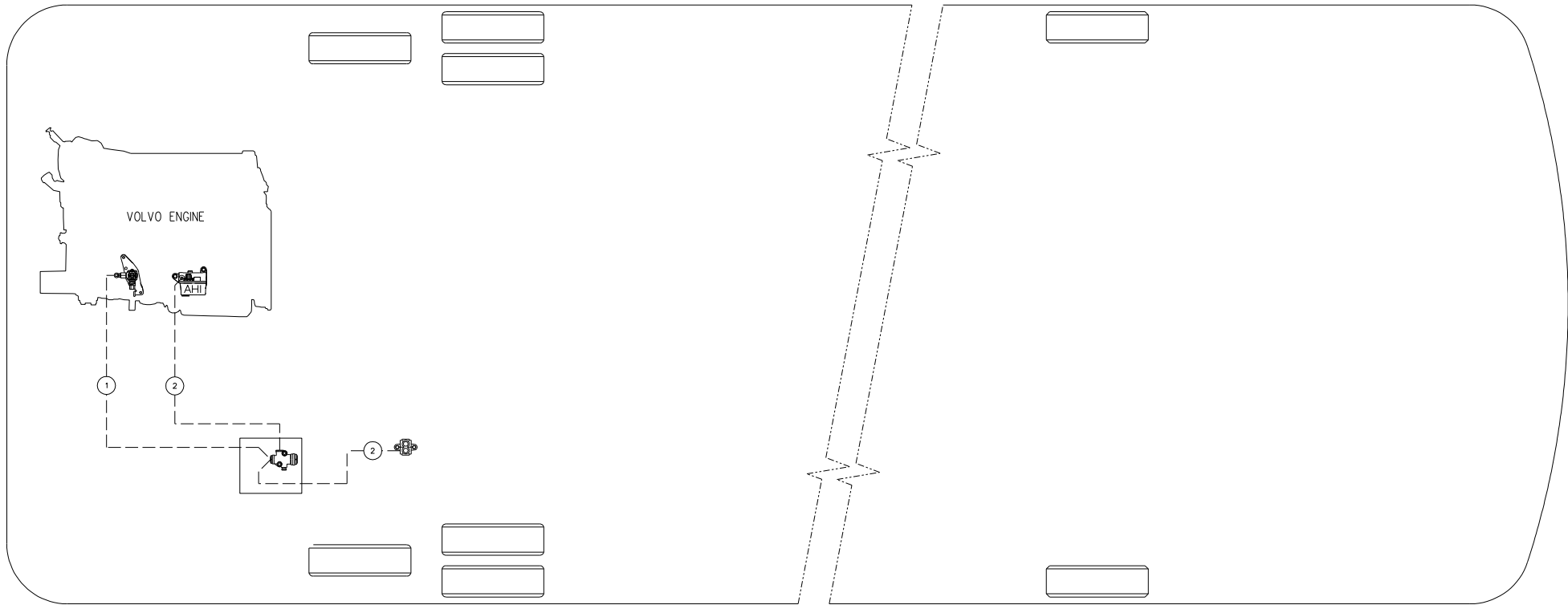

TUBE COLOR CODING		
ACTIVE	COLOR	CIRCUIT
---	BLACK	ACCESSORIES

BALLOON	PIPE
*1	HOSE ASS'Y
*2	1/4" O.D. BLACK

PREVOST®

DESCRIPTION: H3-45 COACHES, WITH INDEPENDENT FRONT SUSPENSION (I.F.S.),
WITHOUT
OUTPUT RETARDER ON WORLD TRANSMISSION

REV.: B
DATE: 2011/02

PAGE:
D140380 P8.1

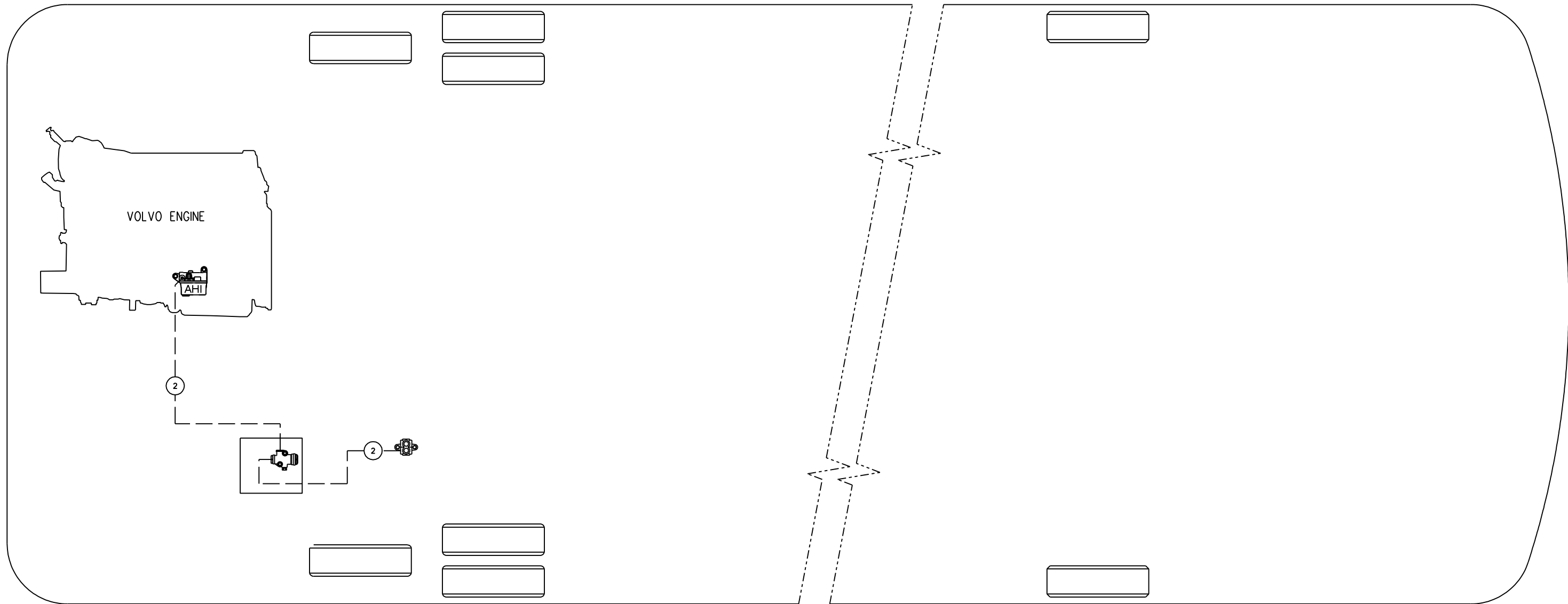

TUBE COLOR CODING		
ACTIVE	COLOR	CIRCUIT
---	BLACK	ACCESSORIES

BALLOON	PIPE
*1	---
*2	1/4" O.D. BLACK

PREVOST®

DESCRIPTION: H3-45 COACHES, WITH INDEPENDENT FRONT SUSPENSION (I.F.S.),
WITHOUT
OUTPUT RETARDER ON WORLD TRANSMISSION

REV.: C
DATE: 2011/12

PAGE:
D140380 P8.1

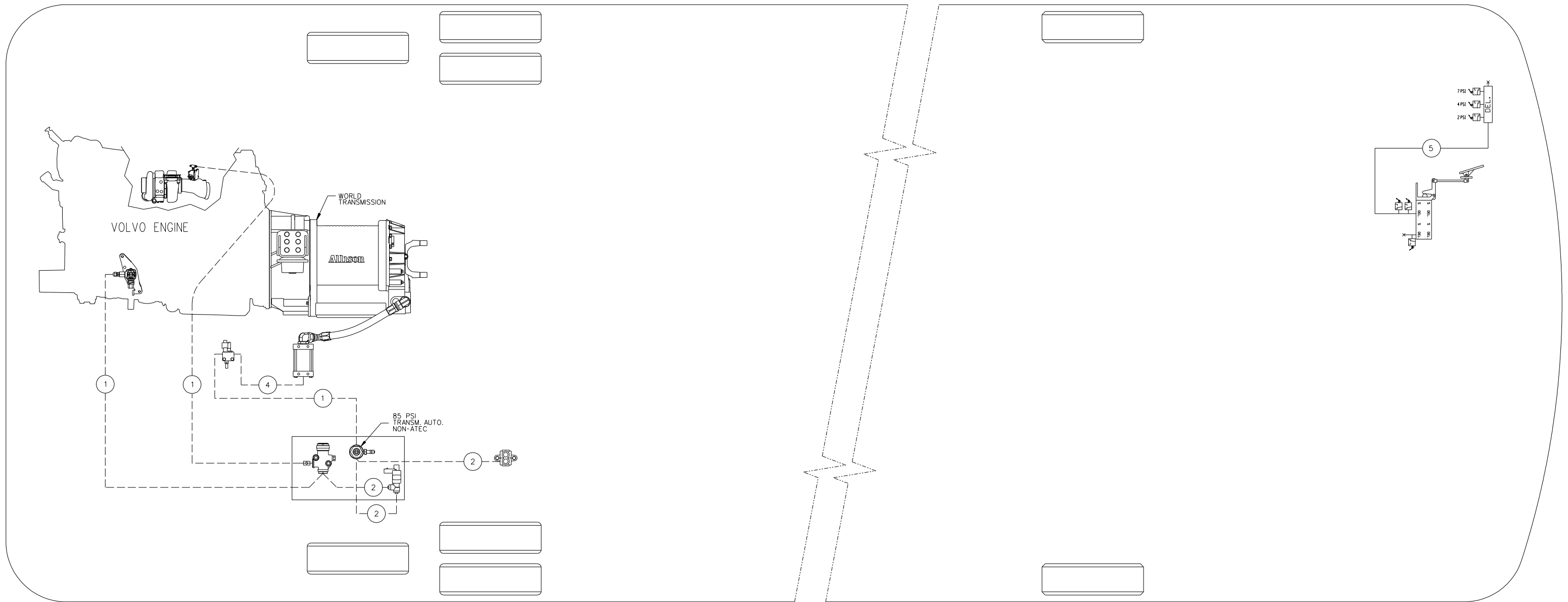

TUBE COLOR CODING		
ACTIVE	COLOR	CIRCUIT
----	BLACK	ACCESSORIES
—	GREEN	PRIMARY & SUPPLY

BALLOON	PIPE
#1	HOSE ASS'Y
#2	1/4" O.D. BLACK
#3	3/8" O.D. BLACK
#4	1/2" O.D. BLACK
#5	3/8" O.D. GREEN

PREVOST®

DESCRIPTION:

H3-45 COACHES,
WITH INDEPENDENT FRONT SUSPENSION (I.F.S.)
& OUTPUT RETARDER ON WORLD TRANSMISSION

REV.:

A

DATE:

2010/09

PAGE:

D140380 P9.1

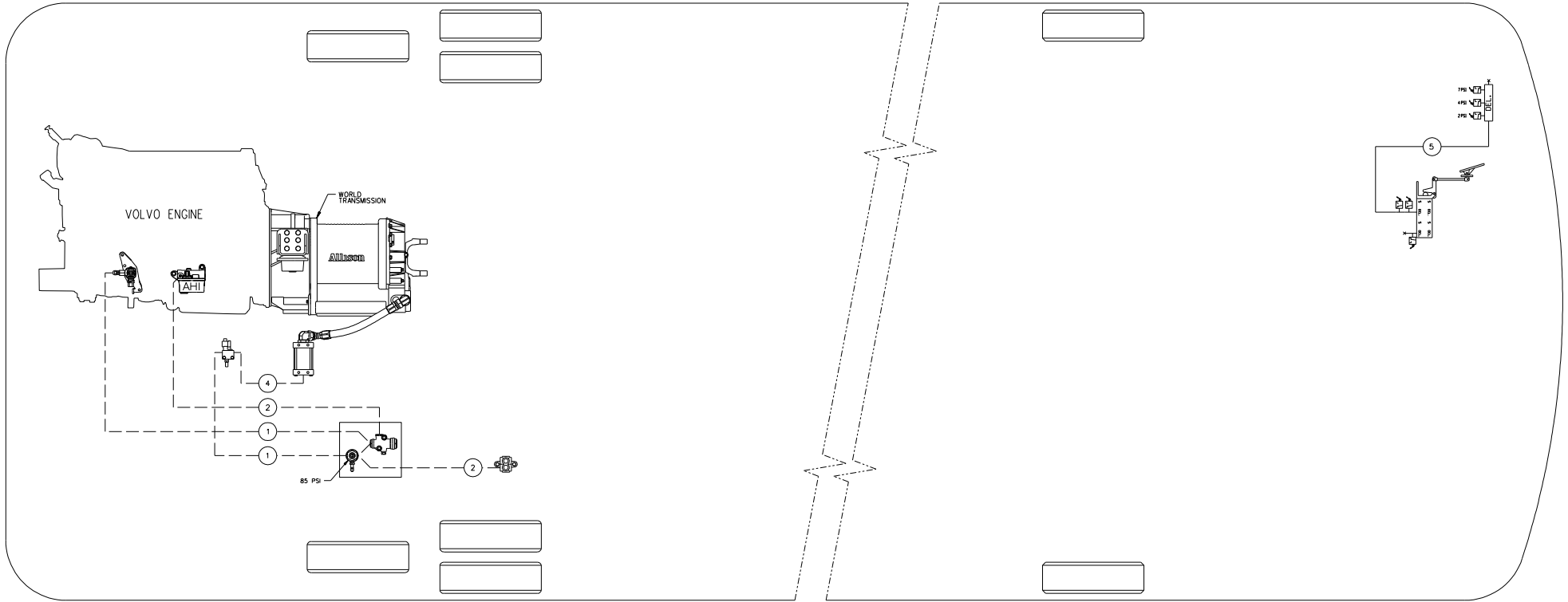

TUBE COLOR CODING	
ACTIVE COLOR	CIRCUIT
---	BLACK ACCESSORIES
---	GREEN PRIMARY & SUPPLY

BALLOON	PIPE
*1	HOSE ASS'Y
*2	1/4" O.D. BLACK
*3	3/8" O.D. BLACK
*4	1/2" O.D. BLACK
*5	3/8" O.D. GREEN

PREVOST®

DESCRIPTION: H3-45 COACHES,
WITH INDEPENDENT FRONT SUSPENSION (I.F.S.)
& OUTPUT RETARDER ON WORLD TRANSMISSION

REV.: B
DATE: 2011/02

PAGE: D140380 P9.1

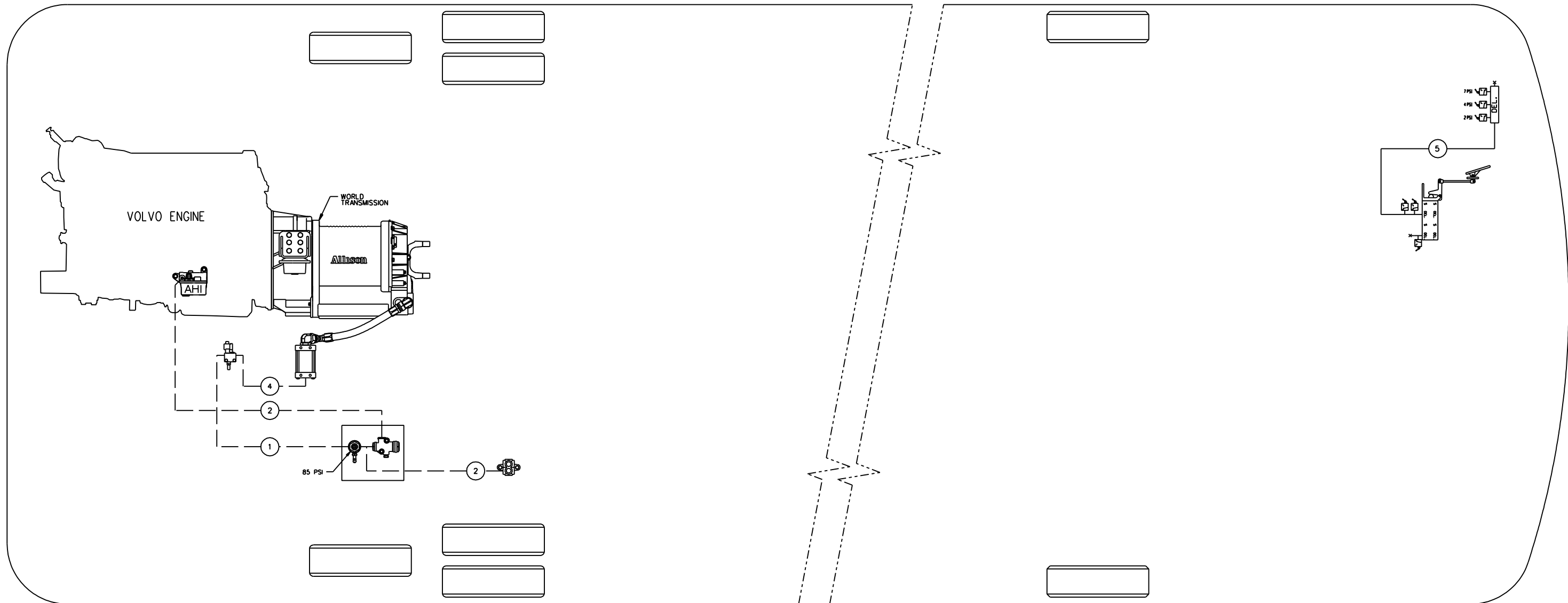

TUBE COLOR CODING		
ACTIVE	COLOR	CIRCUIT
---	BLACK	ACCESSORIES
---	GREEN	PRIMARY & SUPPLY

BALLOON	PIPE
*1	HOSE ASS'Y
*2	1/4" O.D. BLACK
*3	3/8" O.D. BLACK
*4	1/2" O.D. BLACK
*5	3/8" O.D. GREEN

PREVOST®

DESCRIPTION: H3-45 COACHES,
WITH INDEPENDENT FRONT SUSPENSION (I.F.S.)
& OUTPUT RETARDER ON WORLD TRANSMISSION

REV.: C
DATE: 2011/12

PAGE:
D140380 P9.1

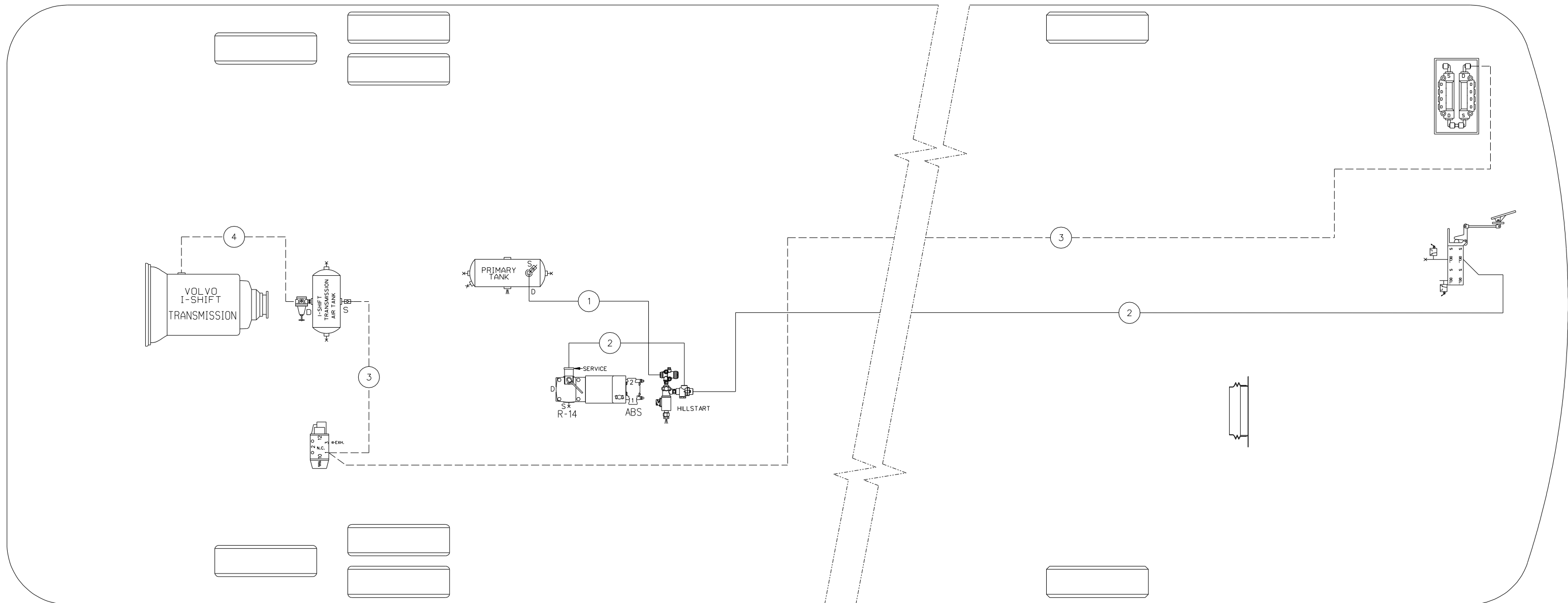

TUBE COLOR CODING	
ACTIVE COLOR	CIRCUIT
— (Green)	PRIMARY & SUPPLY
- - - (Black)	ACCESSORIES

BALLOON	PIPE
#1	3/8" O.D. GREEN
#2	1/2" O.D. GREEN
#3	3/8" O.D. BLACK
#4	1/2" O.D. BLACK

PREVOST®

DESCRIPTION: H3-45 COACHES, WITH INDEPENDENT FRONT SUSPENSION (I.F.S.) WITH I-SHIFT TRANSMISSION OPTION

REV.: A
DATE: 2010/09

PAGE: D140380 P10.1

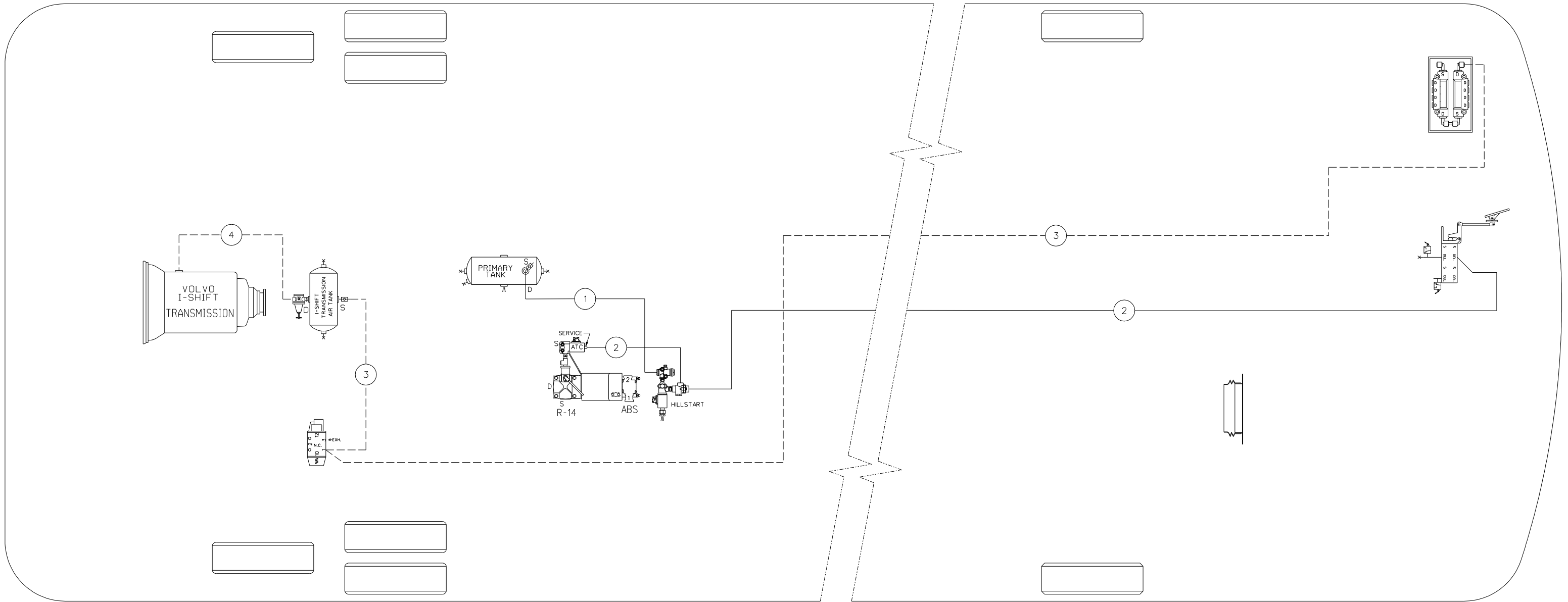

TUBE COLOR CODING	
ACTIVE COLOR	CIRCUIT
—	GREEN PRIMARY & SUPPLY
- - -	BLACK ACCESSORIES

BALLOON	PIPE
#1	3/8" O.D. GREEN
#2	1/2" O.D. GREEN
#3	3/8" O.D. BLACK
#4	1/2" O.D. BLACK

PREVOST®

DESCRIPTION:

H3-45 COACHES, WITH INDEPENDENT FRONT SUSPENSION (I.F.S.)
WITH ESP & I-SHIFT TRANSMISSION OPTIONS

REV.:

A

DATE:

2010/09

PAGE:

D140380 P11.1

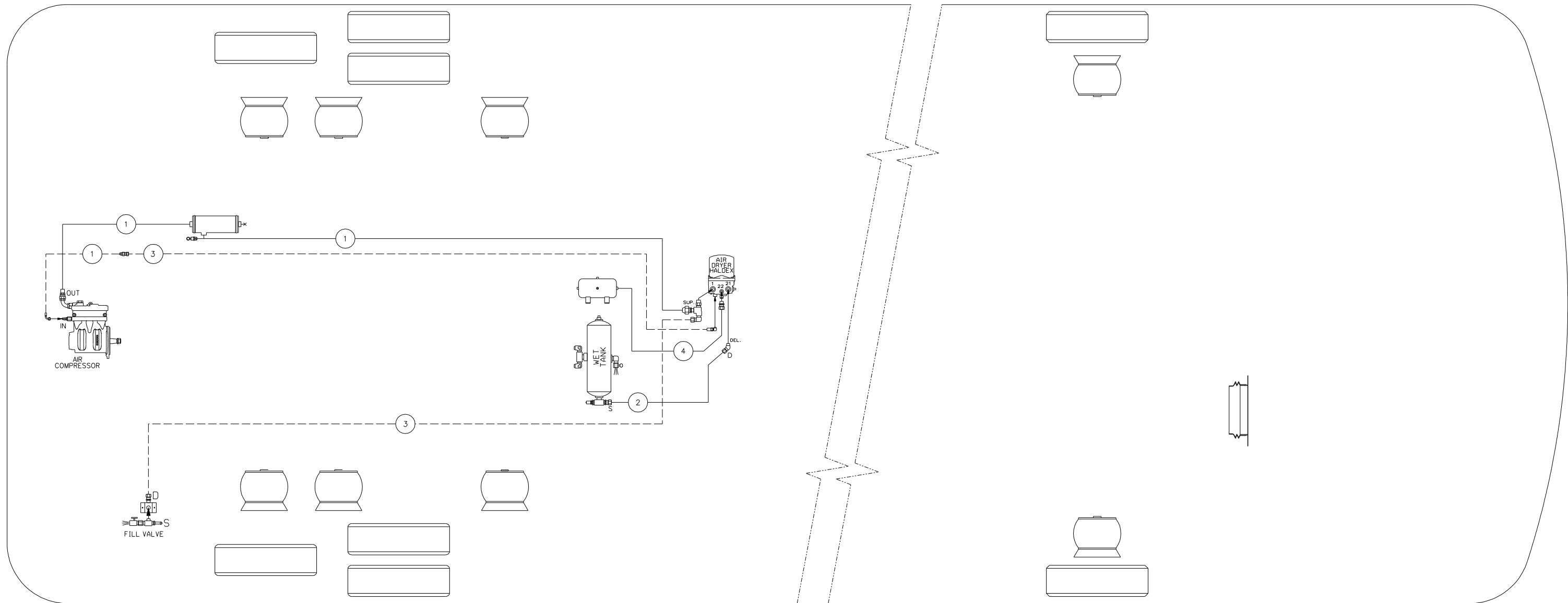

TUBE COLOR CODING		
ACTIVE	COLOR	CIRCUIT
—	GREEN	PRIMARY & SUPPLY
- - -	BLACK	ACCESSORIES

BALLOON	PIPE
#1	HOSE ASS'Y
#2	3/4" O.D. GREEN
#3	1/4" O.D. BLACK
#4	3/8" O.D. GREY

PREVOST®

DESCRIPTION:

H3-45 COACHES, WITH INDEPENDENT FRONT SUSPENSION (I.F.S.), AND HALDEX AIR DRYER

REV.:

A

DATE:

2010/09

PAGE:

D140380 P12.1

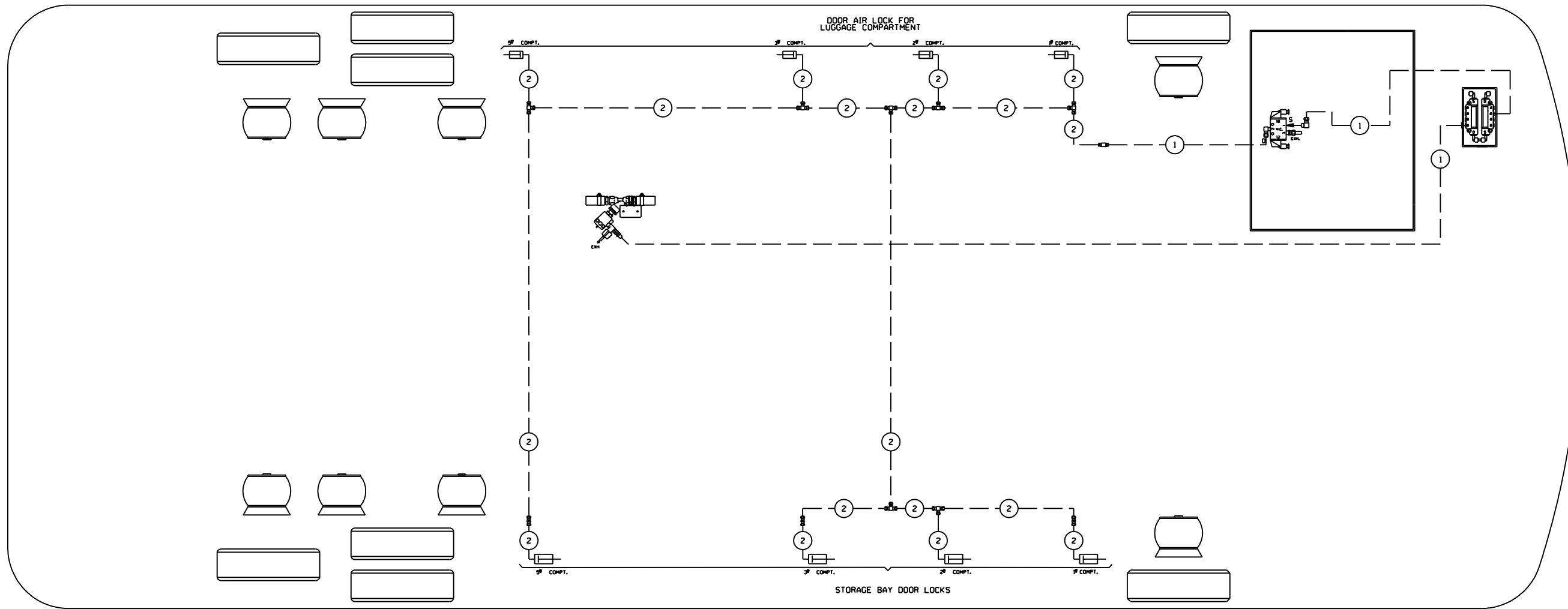

BALLOON	PIPE
*1	1/4" O.D. BLACK
*2	6mm O.D. BLACK

TUBE COLOR CODING	
ACTIVE	COLOR
---	BLACK
---	ACCESSORIES

PREVOST®

DESCRIPTION:
 H3-45 COACHES,
 WITH INDEPENDENT FRONT SUSPENSION (I.F.S.)
 WITH PNEUMATIC STORAGE BAY DOOR LOCKS

REV.: A
 DATE: 2010/09

PAGE:
 D140380 P13.1